

2020 CATALOGUE

2020 CATALOGUE



SPECIALIZED MANUFACTURER  
LED LIGHTING PRODUCTS



# CONTENTS

SPECIALIZED MANUFACTURER  
LED LIGHTING PRODUCTS



07-80 GROUND LIGHT

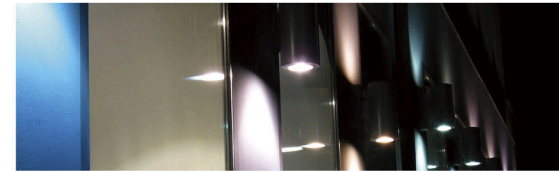

135-154 WALL LIGHT



83-86 FOUNTAIN LIGHT

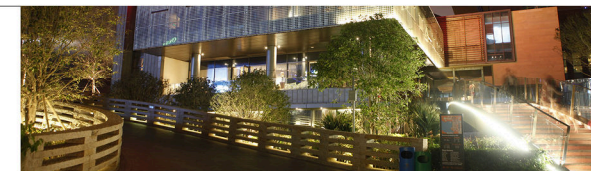

157-162 SPIKE LIGHT



89-112 SPOT LIGHT



165-170 QUICK INSTALL LIGHT

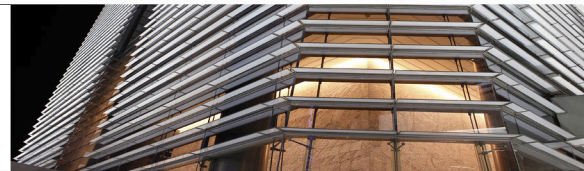

115-126 LINE LIGHTING

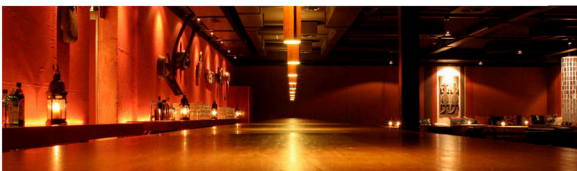

129-132 LED COMPONENTS



173-185 ACCESSORIES



# GROUND LIGHT

SPECIALIZED MANUFACTURER  
LED LIGHTING PRODUCTS





■ EU1960

Marine grade 316 stainless steel fixture complete with integral CREE LED package. Fixture rated to IP68. Suitable for the illumination of small/medium trees, building exteriors, columns if the voltage less than 18W. Above 18W, the luminaires may only be operated under water, recessed luminaires for private and public swimming pools. Underwater luminaires in various sizes and light outputs for installation in concrete, foil, metal or synthetic pools. To avoid harmful deposits and dirt on the luminaires, the water must have a neutral pH value and must be free of components that attack metal.

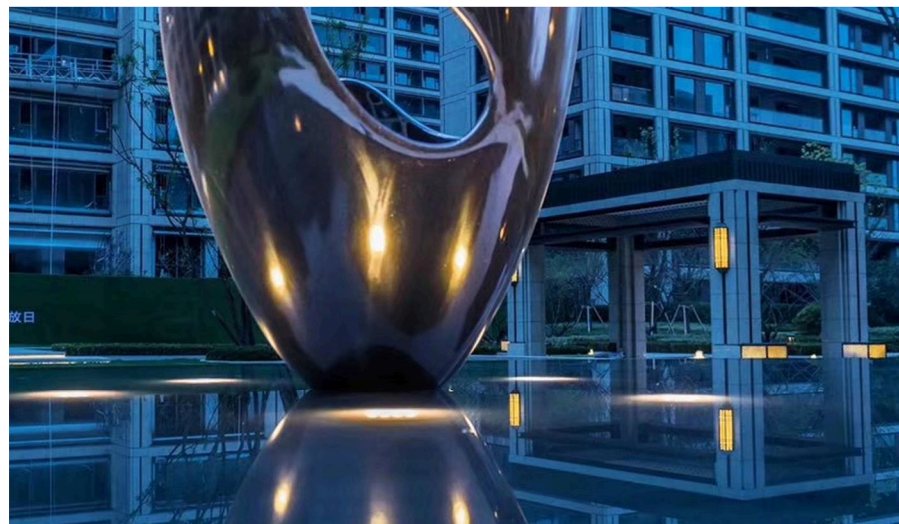

DESCRIPTION

- LED Light source** High Power LED
- Light Color** CW,WW,NW,Red,Green,Blue,Amber
- Material** SUS316(Lamp cap)+SUS316(Lamp cup)
- Optics** 20° / 60° (10° / 30° / 45°)
- Power** 12W
- Power supply** N/A
- Dimension** D173XH50(H71)
- Weight** 1.48kg
- IP Rating** IP68
- Approvals** CE,RoHS
- Ambient temperature** -20°C ~ +45°C
- Average life** 50,000Hrs
- Accessories(Optional)** YES
- Applications** Indoor / Outdoor / Landscape / Submersible

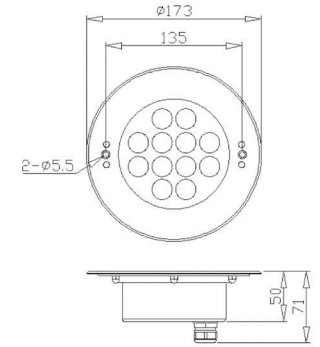

Model No.	LED Brand	Color	Beam	PowerMode	Input	Wiring	Cable	Power	Luminous Flux	Dimension	DrillSize
EU1960	CREE	CW,WW,NW,Red,Green,Blue,Amber	S20/F60 (10/30/45)	Constant current	350mA	Series	3M 2X0.75mm <sup>2</sup> Cable	12W	1000LM	D173XH50	D155
EU1960D	CREE	CW,WW,NW,Red,Green,Blue,Amber	S20/F60 (10/30/45)	Constant voltage	24VDC	Parallel	3M 2X0.75mm <sup>2</sup> Cable	13W	1000LM	D173XH50	D155
EU1960D-M	OSRAM	CW,WW,NW,Red,Green,Blue,Amber	120	Constant voltage	24VDC	Parallel	3M 4X0.5mm <sup>2</sup> Cable	13W	500LM	D173XH50	D155
EU1960DMX	CREE	CW,WW,NW,Red,Green,Blue,Amber	S20/F60 (10/30/45)	Constant voltage	24VDC DMX Controller	Parallel	3M 2X0.75mm <sup>2</sup> Cable	13W	1000LM	D173XH50	D155
* EU1960D-24W	CREE	CW,WW,NW,Red,Green,Blue,Amber	S20/F60 (10/30/45)	Constant voltage	24VDC DMX Controller	Series	3M 2X0.75mm <sup>2</sup> Cable	24W	2000LM	D173XH50	D155
* EU1960D-36W	CREE	CW,WW,NW	S20/F60 (10/30/45)	Constant voltage	24VDC DMX Controller	Parallel	3M 4X0.5mm <sup>2</sup> Cable	36W	2800LM	D173XH50	D155
EU1960DMX-RGB	Edison	RGB,RGBW	S20/F60 (10/30/45)	Constant voltage	24VDC DMX Controller	Parallel	3M 4X0.5mm <sup>2</sup> Cable	13W	N/A	D173XH50	D155
* EU1960DMX-24W-RGB	Edison	RGB,RGBW	S20/F60 (10/30/45)	Constant voltage	24VDC DMX Controller	Parallel	3M 4X0.5mm <sup>2</sup> Cable	24W	N/A	D173XH50	D155
* EU1960DMX-36W-RGBW	Edison	RGBW	S20/F60 (10/30/45)	Constant voltage	24VDC DMX Controller	Parallel	3M 4X0.5mm <sup>2</sup> Cable	36W	N/A	D173XH50	D155

\* Underwater use only

\*IES Data support.

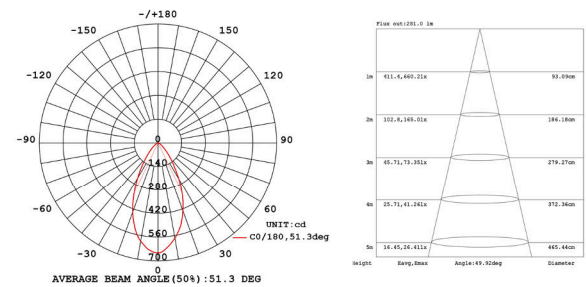

LED Colours

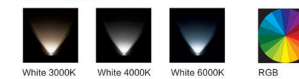

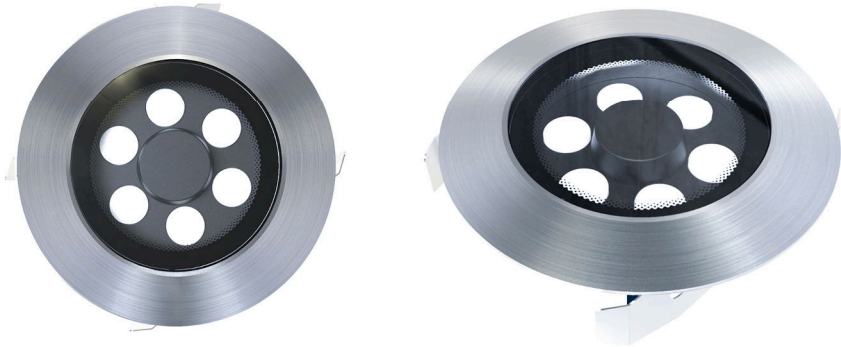

DESCRIPTION

**LED Light source** High Power LED  
**Light Color** CW,WW,NW,Red,Green,Blue,Amber  
**Material** SUS316  
**Optics** 10° / 45° (30° / 60°)  
**Power** 6W  
**Power supply** N/A  
**Dimension** D107 X H47  
**Weight** 0.8kg  
**IP Rating** IP68  
**Approvals** CE,RoHS  
**Ambient temperature** -20°C ~ +45°C  
**Average life** 50,000Hrs  
**Accessories(Optional)** N/A  
**Applications** Indoor/Outdoor/Landscape/Submersible

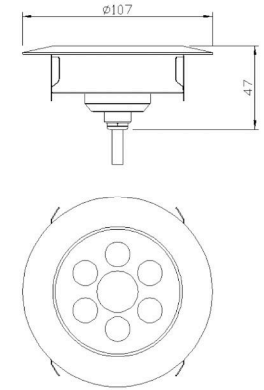

■ EU1920

Marine grade 316 stainless steel fixture complete with integral CREE LED package. Fixture rated to IP68. Suitable for the illumination of small/medium trees, building exteriors, columns if the voltage less than 9W. Above 9W, The luminaires may only be operated under water, recessed luminaires for private and public swimming pools. Underwater luminaires in various sizes and light outputs for installation in concrete, foil, metal or synthetic pools. To avoid harmful deposits and dirt on the luminaires, the water must have a neutral pH value and must be free of components that attack metal.

Model No.	LED Brand	Color	Beam	PowerMode	Input	Wiring	Cable	Power	Luminous Flux	Dimension	DrillSize
EU1920	CREE	CW,WW,NW,Red,Green,Blue,Amber	S10/F45(30/60)	Constant current	350mA	Series	3M 2X0.75mm <sup>2</sup> Cable	6W	500LM	D107XH47	D95
EU1920D	CREE	CW,WW,NW,Red,Green,Blue,Amber	S10/F45(30/60)	Constant voltage	24VDC	Parallel	3M 2X0.75mm <sup>2</sup> Cable	6.5W	500LM	D107XH47	D95
EU1920DMX	CREE	CW,WW,NW,Red,Green,Blue,Amber	S10/F45(30/60)	Constant voltage	24VDC DMX Controller	Parallel	3M 4X0.5mm <sup>2</sup> Cable	6.5W	500LM	D107XH47	D95
EU1920DMX-RGB	EDISON	RGB	S10/F45(30/60)	Constant voltage	24VDC DMX Controller	Parallel	3M 4X0.5mm <sup>2</sup> Cable	6.5W	N/A	D107XH47	D95

\*IES Data support.

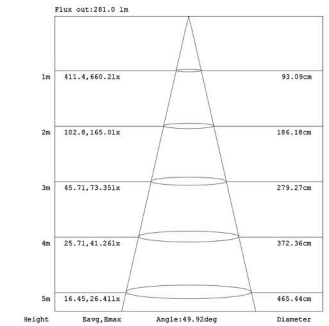
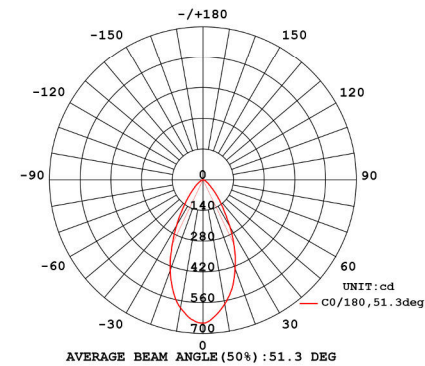
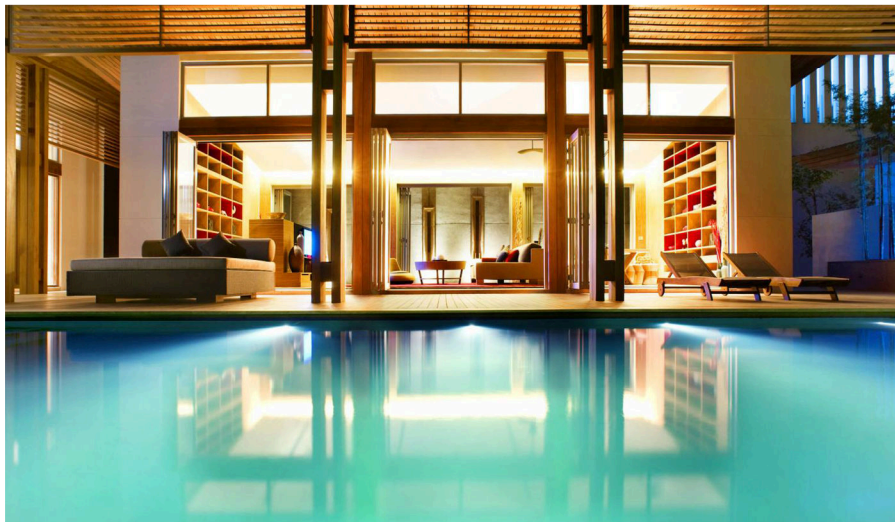

LED Colours





■ EU1965H

Marine grade 316 stainless steel panel with aluminum lamp body. This fixture complete with integral CREE led package. Tempered glass, construction rated to IP67. Recessed light source and black baffle serve to minimize glare.

DESCRIPTION

<b>LED Light source</b>	High Power LED
<b>Light Color</b>	CW,WW,NW
<b>Material</b>	SUS316(Lamp cap)+Aluminium(Lamp cup)
<b>Optics</b>	20° / 60°
<b>Power</b>	6W
<b>Power supply</b>	N/A
<b>Dimention</b>	D60XH53
<b>Weight</b>	N/A
<b>IP Rating</b>	IP67
<b>Approvals</b>	CE,RoHS
<b>Ambient temperature</b>	-20°C ~ +45°C
<b>Average life</b>	50,000Hrs
<b>Accessories(Optional)</b>	Yes
<b>Applications</b>	Indoor/Outdoor/Landscape

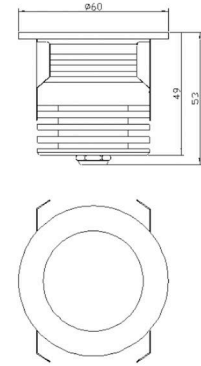

Model No.	LED Brand	Color	Beam	PowerMode	Input	Wiring	Cable	Power	Luminous Flux	Dimention	DrillSize
EU1965H	CREE	CW,WW,NW	S20/F60	Constant current	550mA@11.3VDC	Series	3M 2X0.75mm <sup>2</sup> Cable	6W	500LM	D60XH53	D50
EU1965HD	CREE	CW,WW,NW	S20/F60	Constant voltage	24VDC	Parallel	3M 2X0.75mm <sup>2</sup> Cable	6W	500LM	D60XH53	D50

\*IES Data support.

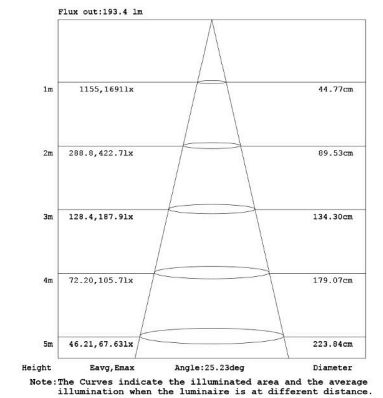
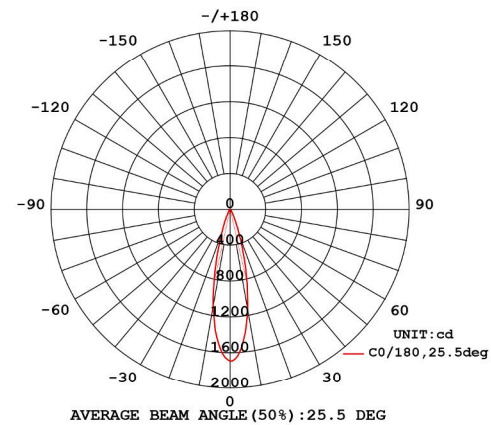

LED Colours

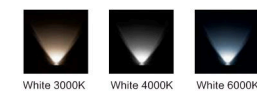



**DESCRIPTION**

<b>LED Light source</b>	High Power LED
<b>Light Color</b>	CW,WW,NW
<b>Material</b>	SUS316(Lamp cap)+Aluminium(Lamp cup)
<b>Optics</b>	3°
<b>Power</b>	7W
<b>Power supply</b>	N/A
<b>Dimension</b>	D90X75
<b>Weight</b>	N/A
<b>IP Rating</b>	IP67
<b>Approvals</b>	CE,RoHS
<b>Ambient temperature</b>	-20°C ~ +45°C
<b>Average life</b>	50,000Hrs
<b>Accessories(Optional)</b>	N/A
<b>Applications</b>	Indoor/Outdoor/Landscape

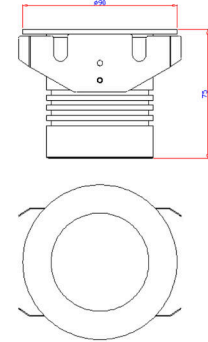

Model No.	LED Brand	Color	Beam	PowerMode	Input	Wiring	Cable	Power	Luminous Flux	Dimension	DrillSize
EU1968	CREE	CW,WW,NW	3°	Constant current	600mA@11.3VDC	Series	3M 2X0.75mm <sup>2</sup> Cable	7W	600LM	D90 X H75	D70
EU1968D	CREE	CW,WW,NW	3°	Constant voltage	24VDC	Parallel	3M 2X0.75mm <sup>2</sup> Cable	7.5W	600LM	D90 X H75	D70
EU1968DMX	CREE	CW,WW,NW	3°	Constant voltage	24VDC	Parallel	3M 4X0.5mm <sup>2</sup> Cable	7.5W	600LM	D90 X H75	D70

■ **EU1968**

Marine grade 316 stainless steel panel with aluminum lamp body. This fixture complete with integral CREE led package. Tempered glass, construction rated to IP67.

\*IES Data support.

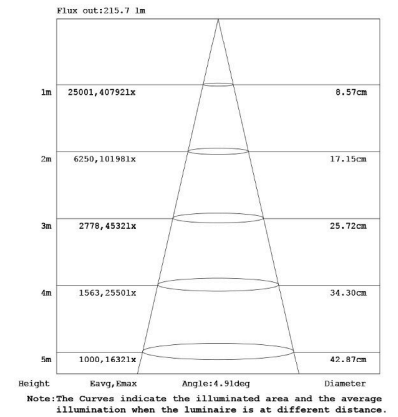
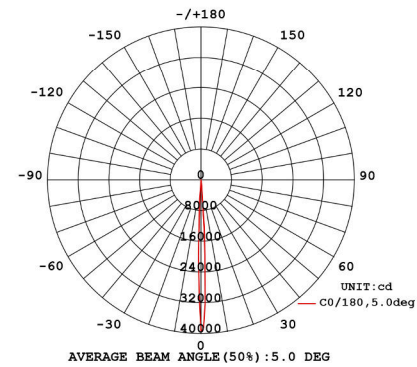
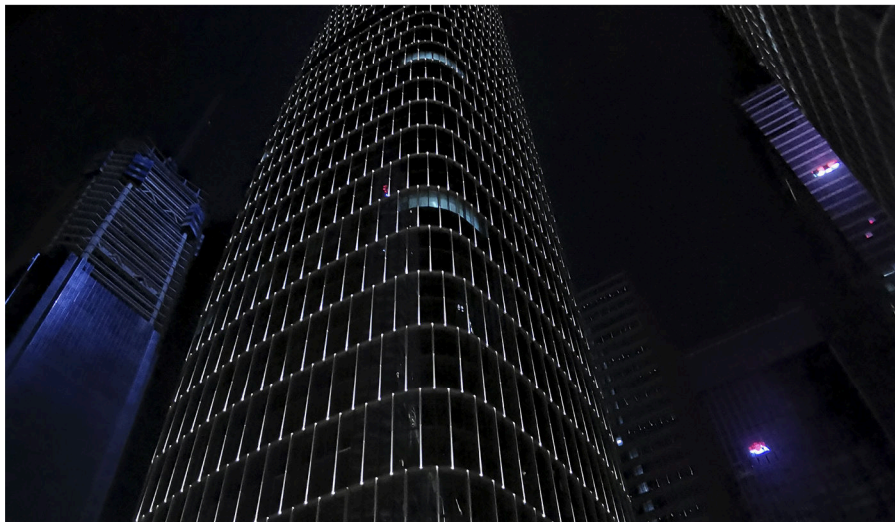

**LED Colours**

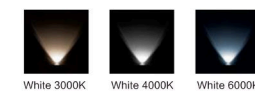





**DESCRIPTION**

LED Light source	High Power LED
Light Color	RGB,CW,WW,NW,Red,Green,Blue,Amber
Material	SUS316
Optics	F40°
Power	15W / 20W
Power supply	12VDC(12-30VDC)
Dimention	D100X142
Weight	1650g
IP Rating	IP68
Approvals	CE,RoHS,IP
Ambient temperature	-20°C ~ +45°C
Average life	50,000Hrs
Accessories(Optional)	N/A
Applications	Indoor/Outdoor/Landscape/ Submersible/Yachting
Optional brand	CREE

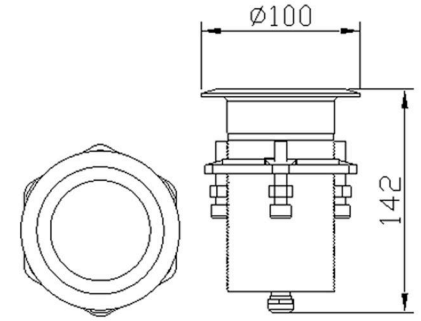

■ **BL100**

Marine grade 316 stainless steel surface mounted fixture complete with high power CREE LED package.Tempered glass, fixture rated to IP68 allowing to use on yachts, ships.With high strength, extra-thick tempered glass,the product has an IK10 (protection against shock up to 20 joules). Able to withstand harsh environments.Maximum hull thickness:<100mm (~ 3.9")

Model No.	LED Brand	Color	Beam	PowerMode	Input	Wiring	Cable	Power	Luminous Flux	Dimention	DrillSize
BL100D	CREE	CW	F40	Constant voltage	12VDC	Parallel	1.1M 2X0.75mm <sup>2</sup> Cable	20W	1500LM	D100X142	D75
BL100D	CREE	Blue	F40	Constant voltage	12VDC	Parallel	1.1M 2X0.75mm <sup>2</sup> Cable	15W	500LM	D100X142	D75

\*IES Data support.

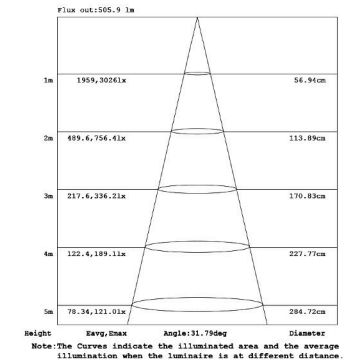
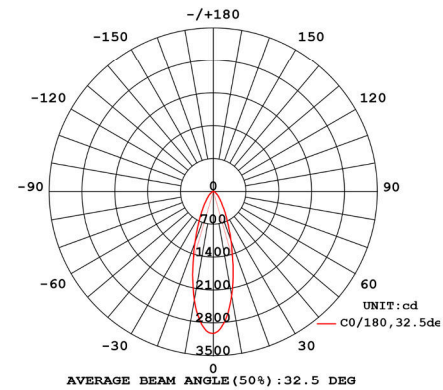

**LED Colours**

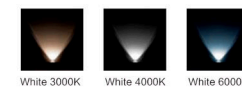



**DESCRIPTION**

<b>LED Light source</b>	High Power LED
<b>Light Color</b>	RGB,CW,WW,NW,Red,Green,Blue,Amber
<b>Material</b>	SUS316(Lamp cap)+Aluminium(Lamp cup)
<b>Optics</b>	15° / S20° / 30° / 45° / F60°
<b>Power</b>	12W
<b>Power supply</b>	350mA or 24VDC
<b>Dimension</b>	550X76Xh29
<b>Weight</b>	N/A
<b>IP Rating</b>	IP67
<b>Approvals</b>	CE,RoHS,IP
<b>Ambient temperature</b>	-20°C ~ +45°C
<b>Accessories(Optional)</b>	N/A
<b>Applications</b>	Indoor/Outdoor

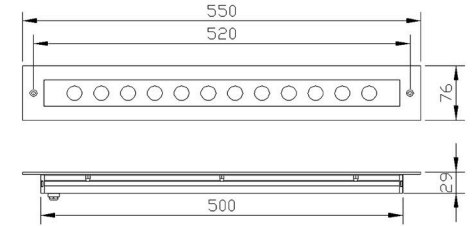

■ **GL310**

Recessed linear fixture rated to IP67.15/20/30/45/60 degree beam Options.Wall/floor-recessed luminaire for use with fluorescent lamps and LEDs.Tempered glass with integrated CREE XPE LED chipset.Luminaire ready for pass-through wiring.

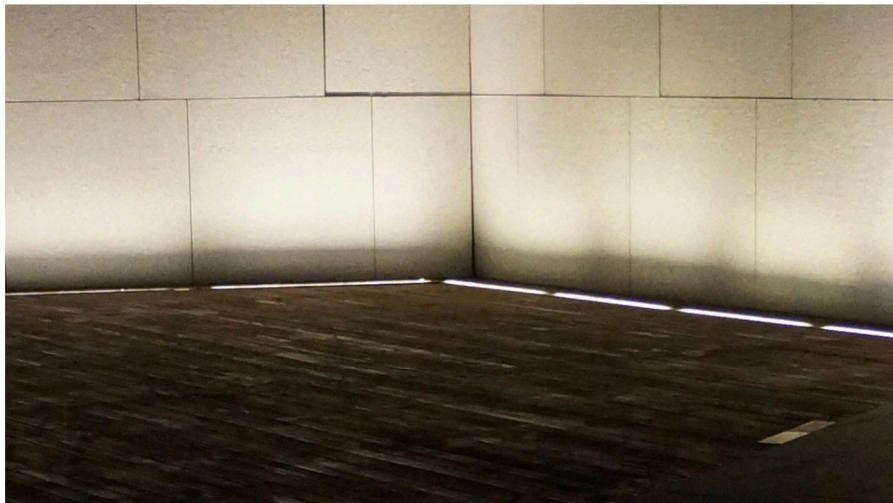

Model No.	LED Brand	Color	Beam	PowerMode	Input	Wiring	Cable	Power	Luminous Flux	Dimension	DrillSize
GL310	CREE	CW,WW, NW,Red Green,Blue,Amber	15/S20/30/45/F60	Constant current	350mA	Series	0.5M 2X0.75mm <sup>2</sup> Cable or 0.2M Plug	12W	800LM	550X75XH29	505X60
GL310D	CREE	CW,WW, NW,Red Green,Blue,Amber	15/S20/30/45/F60	Constant voltage	24VDC	Parallel	0.5M 2X0.75mm <sup>2</sup> Cable or 0.2M Plug	13W	800LM	550X75XH29	505X60
GL310M	OSRAM	CW,WW, NW,Red Green,Blue,Amber	120	Constant current	350mA	Series	0.5M 2X0.75mm <sup>2</sup> Cable or 0.2M Plug	12W	500LM	550X75XH29	505X60
GL310DM	OSRAM	CW,WW, NW,Red Green,Blue,Amber	120	Constant voltage	24VDC	Parallel	0.5M 2X0.75mm <sup>2</sup> Cable or 0.2M Plug	13W	500LM	550X75XH29	505X60
GL310RGB	CREE	4R+4G+4B	15/S20/30/45/F60	Constant current	350mA	Series	0.5M 4X0.5mm <sup>2</sup> Cable or 0.2M Plug	12W	N/A	550X75XH29	505X60
GL310DMX-RGB	Edison	RGB(Fullcolor)	15/S20/30/45/F60	Constant voltage	24VDC DMX Controller	Parallel	0.5M 4X0.5mm <sup>2</sup> Cable or 0.2M Plug	13W	N/A	550X75XH29	505X60

DMX decoder in built

\*IES Data support.

\*Length and power could be customized.

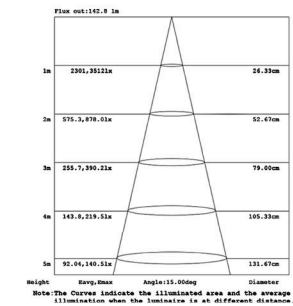
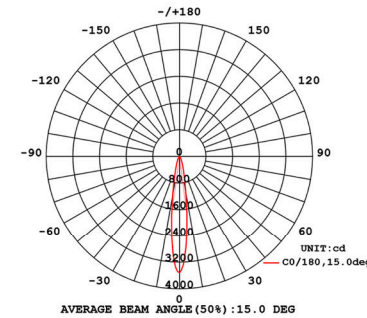

**LED Colours**

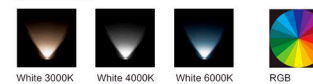



■ GL240

Marine grade 316 stainless steel bezel panel with aluminum lamp Body, Tempered glass, In-ground floodlight fixture complete with Integral CREE LED package. 10/20/40/60 degree beam options. No Mechanical joints to light source ensures robust protection against Water ingress. product runs cool meeting all touch temperature Requirements. Suitable for the illumination of small/medium trees.

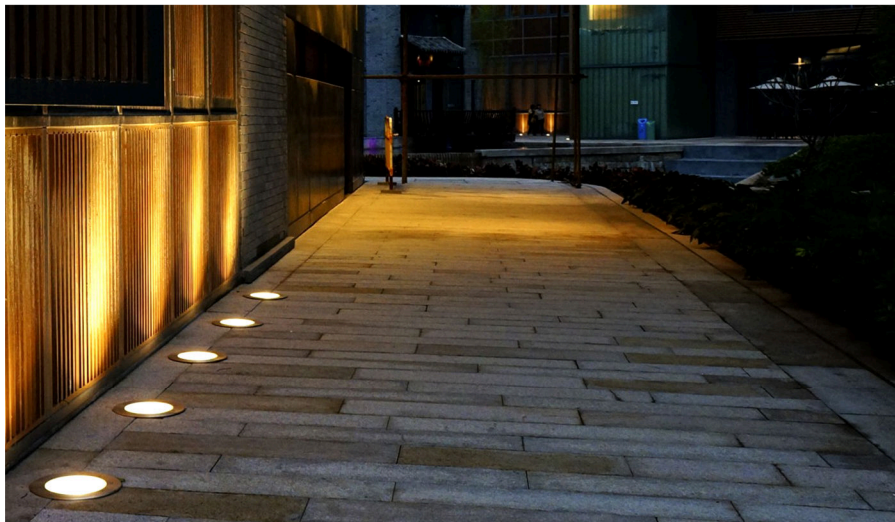

DESCRIPTION

<b>LED Light source</b>	High Power LED
<b>Light Color</b>	RGB,CW,WW,NW,Red,Green,Blue,Amber
<b>Material</b>	SUS316(Lamp cap)+Aluminium(Lamp cup)
<b>Optics</b>	10° / S20° / 40° / F60°
<b>Power</b>	24W
<b>Power supply</b>	N/A
<b>Dimension</b>	D248X55
<b>Weight</b>	3.25kg
<b>IP Rating</b>	IP67
<b>Approvals</b>	CE,RoHS,IP
<b>Ambient temperature</b>	-20°C ~ +45°C
<b>Average life</b>	50,000Hrs
<b>Accessories(Optional)</b>	Yes
<b>Applications</b>	Indoor / Outdoor / Landscape

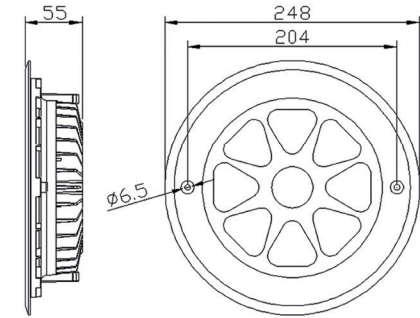

Model No.	LED Brand	Color	Beam	PowerMode	Input	Wiring	Cable	Power	Luminous Flux	Dimension	DrillSize
GL240	CREE	CW,WW, NW,Red,Green,Blue,Amber	10/S20/40/F60	Constant current	350mA	Series	3M 2X0.75mm <sup>2</sup> Cable	24W	2200LM	D248X55	D225
GL240D	CREE	CW,WW, NW,Red,Green,Blue,Amber	10/S20/40/F60	Constant voltage	24VDC	Parallel	3M 2X0.75mm <sup>2</sup> Cable	26W	2200LM	D248X55	D225
GL240DM	OSRAM	CW,WW, NW,Red,Green,Blue,Amber	120	Constant voltage	24VDC	Parallel	3M 2X0.75mm <sup>2</sup> Cable	18W	1400LM	D248X55	D225
GL240RGB	CREE	8R+8G+8B	10/S20/40/F60	Constant current	350mA	Series	2x3M 4X0.5mm <sup>2</sup> Cable	24W	N/A	D248X55	D225
GL240DMX-RGB	CREE	8R+8G+8B	10/S20/40/F60	Constant voltage	24VDC DMX Controller	Parallel	1.1M 4X0.5mm <sup>2</sup> Cable	26W	N/A	D248X55	D225

DMX decoder in built

\*IES Data support.

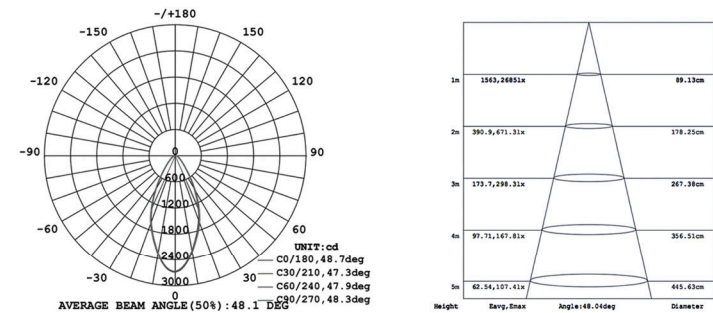

LED Colours





■ GL180

Marine grade 316 stainless steel bezel panel with aluminum lamp Body, Tempered glass, this fixture complete with integral CREE LED package. Fixture rated to IP67 with no mechanical joints to light source ensures robust protection against Water ingress. 10/20/40/60 degree beam options. product runs cool meeting all touch temperature requirements. Suitable for the illumination of small/medium trees.

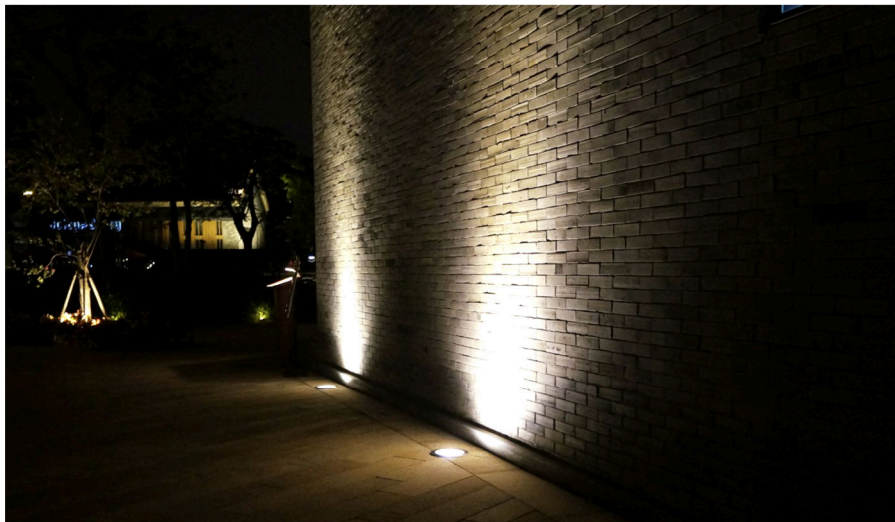

DESCRIPTION

<b>LED Light source</b>	High Power LED
<b>Light Color</b>	RGB,CW,WW,NW,Red,Green,Blue,Amber
<b>Material</b>	SUS316(Lamp cap)+Aluminium(Lamp cup)
<b>Optics</b>	10° / S20° / 40° / F60°
<b>Power</b>	18W
<b>Power supply</b>	N/A
<b>Dimension</b>	D175X51
<b>Weight</b>	1.7KG
<b>IP Rating</b>	IP67
<b>Approvals</b>	CE,RoHS,IP
<b>Ambient temperature</b>	-20°C ~ +45°C
<b>Average life</b>	50,000Hrs
<b>Accessories(Optional)</b>	Yes
<b>Applications</b>	Indoor/Outdoor/Landscape

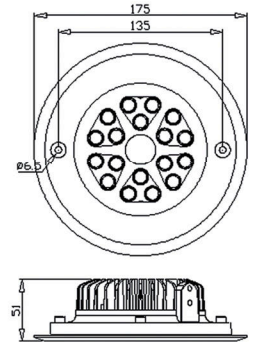

Model No.	LED Brand	Color	Beam	PowerMode	Input	Wiring	Cable	Power	Luminous Flux	Dimension	DrillSize
GL180	CREE	CW,WW, NW,Red, Green,Blue,Amber	10/S20/40/F60	Constant current	350mA	Series	3M 2X0.75mm <sup>2</sup> Cable	18W	1700LM	D175X51	D155
GL180D	CREE	CW,WW, NW,Red Green,Blue,Amber	10/S20/40/F60	Constant voltage	24VDC	Parallel	3M 2X0.75mm <sup>2</sup> Cable	20W	1700LM	D175X51	D155
GL180RGB	CREE	6R+6G+6B	10/S20/40/F60	Constant current	350mA	Series	2x3M 4X0.5mm <sup>2</sup> Cable	18W	N/A	D175X51	D155
GL180DMX-RGB	CREE	6R+6G+6B	10/S20/40/F60	Constant voltage	24VDC DMX Controller	Parallel	1.1M 4X0.5mm <sup>2</sup> Cable	20W	N/A	D175X51	D155
GL180DMX-RGB	Edison	RGB(Fullcolor)	10/S20/40/F60	Constant voltage	24VDC DMX Controller	Parallel	1.1M 4X0.5mm <sup>2</sup> Cable	20W	N/A	D175X51	D155
GL180DMX-RGBW	Edison	RGBW(Fullcolor)	10/S20/40/F60	Constant voltage	24VDC DMX Controller	Parallel	1.1M 4X0.5mm <sup>2</sup> Cable	20W	N/A	D175X51	D155

DMX decoder in built

\*IES Data support.

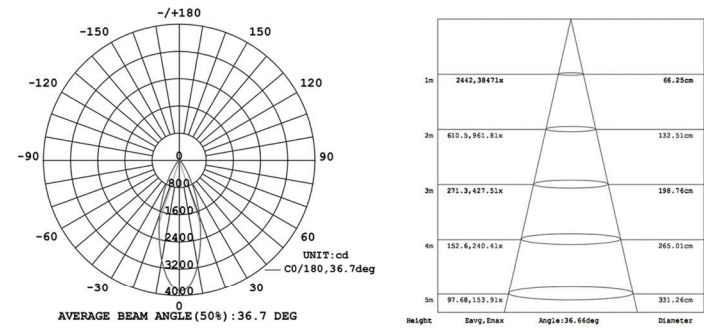

LED Colours

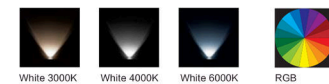



■ GL120

Marine grade 316 stainless steel bezel panel with aluminum lamp Body, Tempered glass, this fixture complete with integral CREE LED package. Fixture rated to IP67 with no Mechanical joints to light source ensures robust protection against Water ingress. 10/20/40/60 degree beam options. product runs cool meeting all touch temperature requirements. Suitable for the illumination of small/medium trees.



DESCRIPTION

LED Light source	High Power LED
Light Color	RGB, CW, WW, NW, Red, Green, Blue, Amber
Material	SUS316(Lamp cap)+Aluminium(Lamp cup)
Optics	10° / S20° / 40° / F60°
Power	12W
Power supply	N/A
Dimension	D175X51
Weight	1.7KG
IP Rating	IP67
Approvals	CE, RoHS, IP
Ambient temperature	-20°C ~ +45°C
Average life	50,000Hrs
Accessories(Optional)	Yes
Applications	Indoor/Outdoor/Landscape

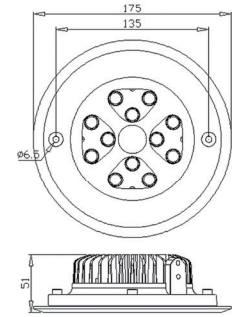

Model No.	LED Brand	Color	Beam	PowerMode	Input	Wiring	Cable	Power	Luminous Flux	Dimension	DrillSize
GL120	CREE	CW, WW, NW, Red Green, Blue, Amber	10/S20/40/F60	Constant current	350mA	Series	3M 2X0.75mm <sup>2</sup> Cable	12W	1300LM	D175X51	D155
GL120D	CREE	CW, WW, NW, Red Green, Blue, Amber	10/S20/40/F60	Constant voltage	24VDC	Parallel	3M 2X0.75mm <sup>2</sup> Cable	13W	1300LM	D175X51	D155
GL120DM	OSRAM	CW, WW, NW, Red Green, Blue, Amber	120	Constant voltage	24VDC	Parallel	3M 2X0.75mm <sup>2</sup> Cable	12W	650LM	D175X51	D155
GL120RGB	CREE	4R+4G+4B	10/S20/40/F60	Constant current	350mA	Series	2x3M 4X0.5mm <sup>2</sup> Cable	12W	N/A	D175X51	D155
GL120DMX-RGB	CREE	4R+4G+4B	10/S20/40/F60	Constant voltage	4VDC DMX Controller	Parallel	1.1M 4X0.5mm <sup>2</sup> Cable	13W	N/A	D175X51	D155
GL120DMX-RGB	Edison	RGB(Fullcolor)	10/S20/40/F60	Constant voltage	24VDC DMX Controller	Parallel	1.1M 4X0.5mm <sup>2</sup> Cable	13W	N/A	D175X51	D155
GL120DMX-RGBW	Edison	RGBW(Fullcolor)	10/S20/40/F60	Constant voltage	24VDC DMX Controller	Parallel	1.1M 4X0.5mm <sup>2</sup> Cable	13W	N/A	D175X51	D155

DMX decoder is built

\*IES Data support.

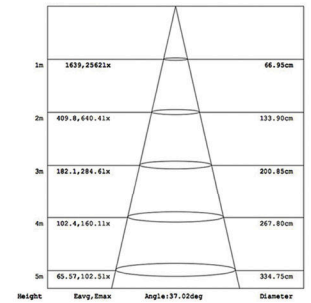
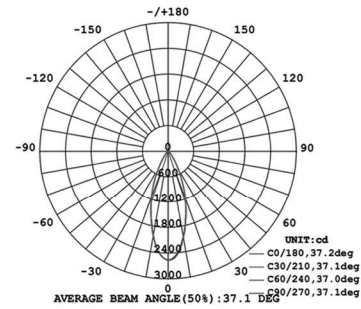

LED Colours

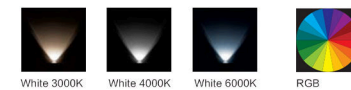

DESCRIPTION

LED Light source	High Power LED
Light Color	RGB,CW,WW,NW,Red,Green,Blue,Amber
Material	SUS316(Lamp cap)+Aluminium(Lamp cup)
Optics	10° / S20° / 40° / F60°
Power	6x1W
Power supply	N/A
Dimension	D107xH52
Weight	1.1KG
IP Rating	IP67
Approvals	CE,RoHS,IP
Ambient temperature	-20°C ~ +45°C
Average life	50,000Hrs
Accessories(Optional)	Yes
Applications	Indoor/Outdoor/Landscape

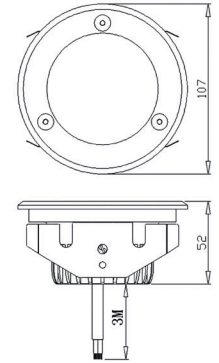

TS080

Optional accessories

GL080

Marine grade 316 stainless steel bezel panel with aluminum lamp body. This fixture complete with integral CREELED package. Tempered glass. Fixture rated to IP67 with no mechanical joints to light source ensures robust protection against Water ingress. 10/20/40/60 degree beam options. product runs cool meeting all touch temperature requirements. Suitable for the illumination of small/medium trees.

Model No.	LED Brand	Color	Beam	PowerMode	Input	Wiring	Cable	Power	Luminous Flux	Dimension	DrillSize
GL080	CREE	CW,WW, NW,Red Green,Blue,Amber	S10/F40	Constant current	350mA	Series	3M 2X0.75mm2 Cable	6W	500LM	D107 X H52	D95
GL080D	CREE	CW,WW, NW,Red Green,Blue,Amber	S10/F40	Constant voltage	24VDC	Parallel	3M 2X0.75mm2 Cable	6.5W	500LM	D107 X H52	D95
GL080-3W	CREE	CW,WW, NW,Red Green,Blue,Amber	10/S20/40/F60	Constant current	350mA	Series	3M 2X0.75mm2 Cable	3W	300LM	D107 X H52	D95
GL080D-3W	CREE	CW,WW, NW,Red Green,Blue,Amber	10/S20/40/F60	Constant voltage	24VDC	Parallel	3M 2X0.75mm2 Cable	3.5W	300LM	D107 X H52	D95
GL080M	OSRAM	CW,WW, NW,Red Green,Blue,Amber	120	Constant current	350mA	Series	3M 2X0.75mm2 Cable	6W	500LM	D107 X H52	D95
GL080RGB	CREE	2R+2G+2B	S10/F40	Constant current	350mA	Series	2x3M 4X0.5mm2 Cable	6W	N/A	D107 X H52	D95
GL080DMX-RGB	CREE	2R+2G+2B	S10/F40	Constant voltage	24VDC DMX Controller	Parallel	1.1M 4X0.5mm2 Cable	6.5W	N/A	D107 X H52	D95
GL080DMX-RGB	Edison	RGB(Fullcolor)	S10/F40	Constant voltage	24VDC DMX Controller	Parallel	1.1M 4X0.5mm2 Cable	6.5W	N/A	D107 X H52	D95
GL080DMX-RGBW	Edison	RGBW(Fullcolor)	S10/F40	Constant voltage	24VDC DMX Controller	Parallel	1.1M 4X0.5mm2 Cable	6.5W	N/A	D107 X H52	D95

DMX decoder is built

\*IES Data support.

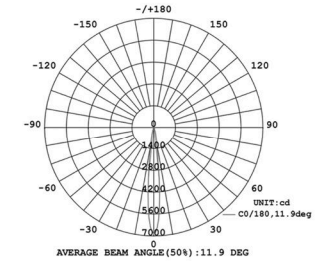
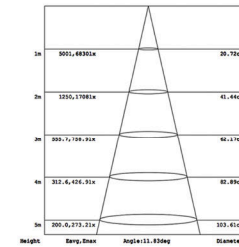
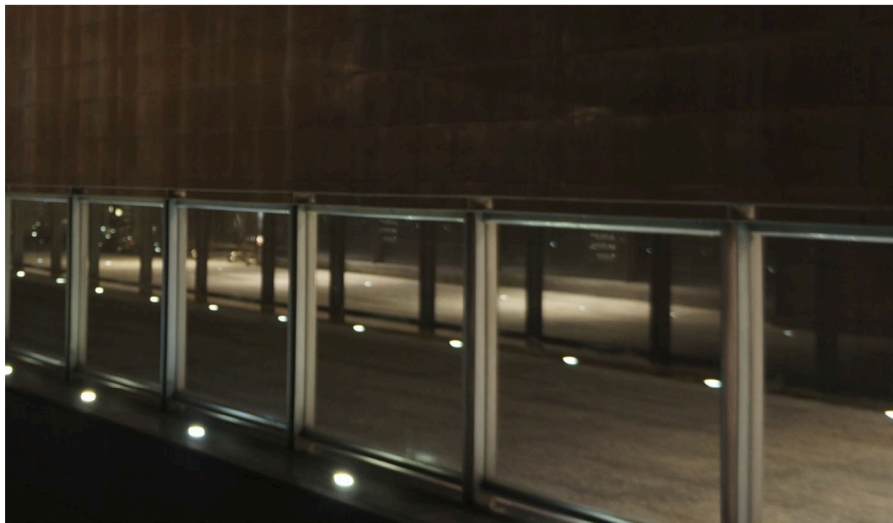

LED Colours

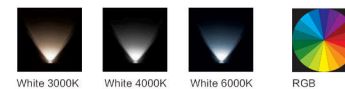



GL112

Miniature recessed fixture complete with integral CREE LED Package and 20/60 degree beam options. Marine Grade 316 Stainless Steel option with construction rated to IP68. Tempered glass, with patented cable waterproof design. Product footprint of 23mm diameter ensures versatile application. In-line driver options include switched, 1-10V and DALI dimmable solutions (3.9")

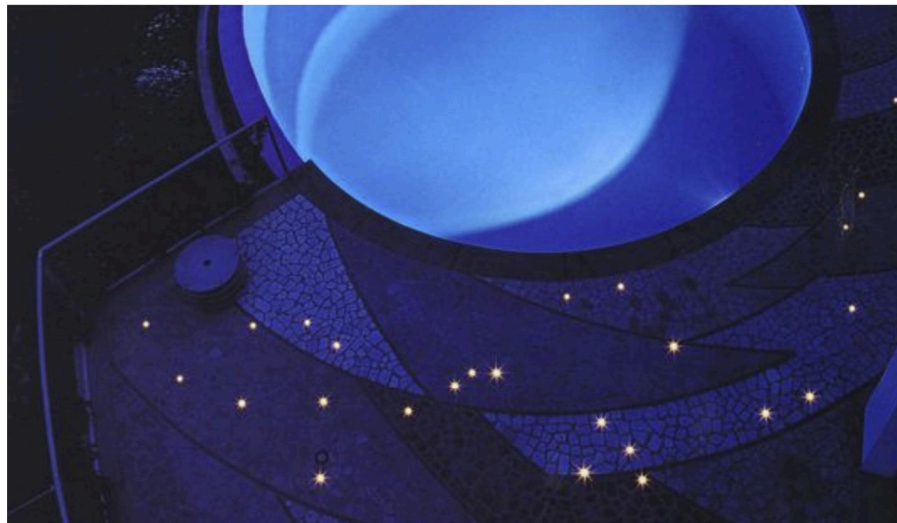

DESCRIPTION

<b>LED Light source</b>	High Power LED
<b>Light Color</b>	RGB, CW, WW, NW, Red, Green, Blue, Amber
<b>Material</b>	SUS316
<b>Optics</b>	S20° / F60°
<b>Power</b>	1W
<b>Power supply</b>	N/A
<b>Dimension</b>	D23X40
<b>Weight</b>	60g
<b>IP Rating</b>	IP68
<b>Approvals</b>	CE, RoHS, IP
<b>Ambient temperature</b>	-20°C ~ +45°C
<b>Average life</b>	50,000Hrs
<b>Accessories(Optional)</b>	Yes
<b>Applications</b>	Indoor/Outdoor/Landscape/Submersible

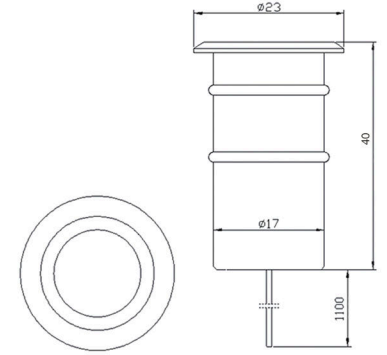

Model No.	LED Brand	Color	Beam	PowerMode	Input	Wiring	Cable	Power	Luminous Flux	Dimension	DrillSize
GL112	CREE	CW, WW, NW, Red, Green, Blue, Amber	S20/F60	Constant current	350mA	Series	1.1M 2X0.4MM <sup>2</sup> Cable	1W	100LM	D23X40	D19
GL112D	CREE	CW, WW, NW, Red, Green, Blue, Amber	S20/F60	Constant voltage	24VDC	Parallel	1.1M 2X0.4MM <sup>2</sup> Cable	1.3W	100LM	D23X40	D19
GL112M	CREE / OSRAM	CW, WW, NW, Red, Green, Blue, Amber	120	Constant voltage	12VDC	Parallel	1.1M 2X0.4MM <sup>2</sup> Cable	0.5W	30LM	D23X40	D19
GL112RGB	Edison	RGB	120	Constant voltage	12VDC	Parallel	1.1M 4X24AWG Cable	0.5W	N/A	D23X40	D19

\*IES Data support.

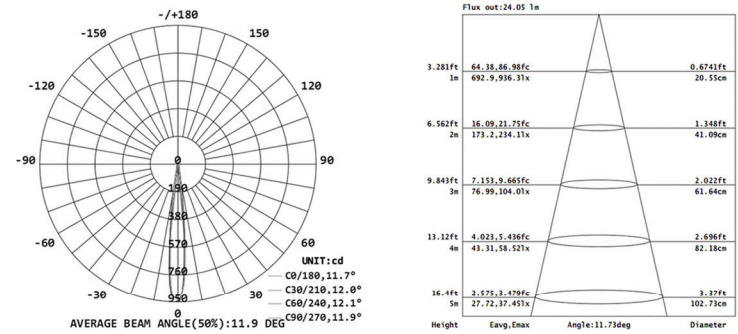

LED Colours





■ GL112H

Miniature recessed fixture complete with integral CREE LED Package and 20/60 degree beam options. Tempered glass with Ultra low-glare, IP68 ground light is made of marine Grade 316 Stainless Steel. Product footprint of 23mm diameter ensures versatile application. In-line driver options include switched, 1-10V and DALI dimmable solutions.

DESCRIPTION

LED Light source	High Power LED
Light Color	CW,WW,NW,Red,Green,Blue,Amber
Material	SUS316
Optics	S20° / F60°
Power	1W
Power supply	N/A
Dimension	D23X40
Weight	60g
IP Rating	IP68
Approvals	CE,RoHS,IP
Ambient temperature	-20°C ~ +45°C
Average life	50,000Hrs
Accessories(Optional)	Yes
Applications	Indoor/Outdoor/Landscape/Submersible

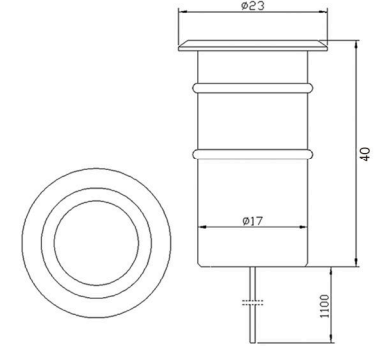

Model No.	LED Brand	Color	Beam	PowerMode	Input	Wiring	Cable	Power	Luminous Flux	Dimension	DrillSize
GL112H	CREE	CW,WW, NW,Red Green,Blue,Amber	S20/F60	Constant current	350mA	Series	1.1M 2X0.4MM <sup>2</sup> Cable	1W	100LM	D23x40	D19
GL112HD	CREE	CW,WW, NW,Red Green,Blue,Amber	S20/F60	Constant voltage	24VDC	Parallel	1.1M 2X0.4MM <sup>2</sup> Cable	1.3W	100LM	D23x45	D19

\*IES Data support.

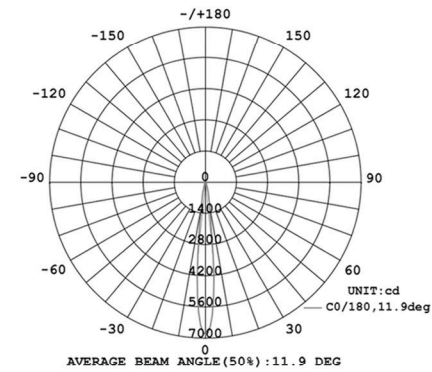

Height	Beam, Smax	Angle: 11.93deg	Diameter
1m	5001,68301x		20.72cm
2m	1250,17081x		41.44cm
3m	555,7758,91x		62.17cm
4m	312,6,426,91x		82.89cm
5m	200,0,273,21x		103.61cm

LED Colours

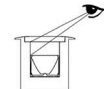
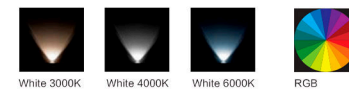





■ GL116

Miniature recessed fixture complete with integral CREE LED Package and 12/45 degree beam options. Tempered glass, Marine grade 316 Stainless Steel construction rated to IP68. Product footprint of 60mm diameter ensures versatile application. In-line driver options include switched, 1-10V and DALI dimmable solutions.



DESCRIPTION

LED Light source	High Power LED
Light Color	RGB,CW,WW,NW,Red,Green,Blue,Amber
Material	SUS316
Optics	S12° / F45°
Power	1W
Power supply	N/A
Dimension	D60X45
Weight	465g
IP Rating	IP68
Approvals	CE,RoHS,IP
Ambient temperature	-20°C ~ +45°C
Average life	50,000Hrs
Accessories(Optional)	Yes
Applications	Indoor/Outdoor/Landscape/Submersible

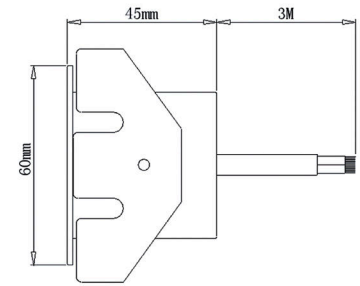

Model No.	LED Brand	Color	Beam	PowerMode	Input	Wiring	Cable	Power	Luminous Flux	Dimension	DrillSize
GL116	CREE	CW,WW, NW,Red Green,Blue,Amber	S12/F45	Constant current	350mA	Series	3M 2X0.75mm <sup>2</sup> Cable	1W	100LM	D60X45	D50
GL116D	CREE	CW,WW, NW,Red Green,Blue,Amber	S12/F45	Constant voltage	24VDC	Parallel	3M 2X0.75mm <sup>2</sup> Cable	1.3W	100LM	D60X45	D50
GL116C	CREE	CW,WW, NW,Red Green,Blue,Amber	S12/F45	Constant current	350mA	Series	3M 2X0.75mm <sup>2</sup> Cable	1W	100LM	D60X45	D50
GL116RGB	Edison	RGB	45	Constant current	350mA	Series	2x3M 4X0.5mm <sup>2</sup> Cable	3W	N/A	D60X45	D50
GL116DMX-RGB	Edison	RGB	S12/F45	Constant voltage	24VDC DMX	Parallel	1.1M 4X0.5mm <sup>2</sup> Cable	3.5W	N/A	D60X45	D50

DMX decoder in built

\*IES Data support.

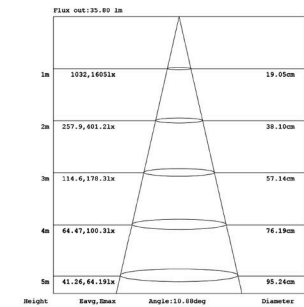
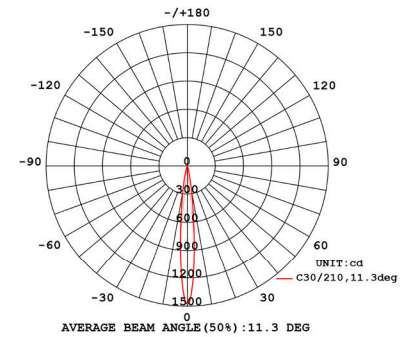

LED Colours



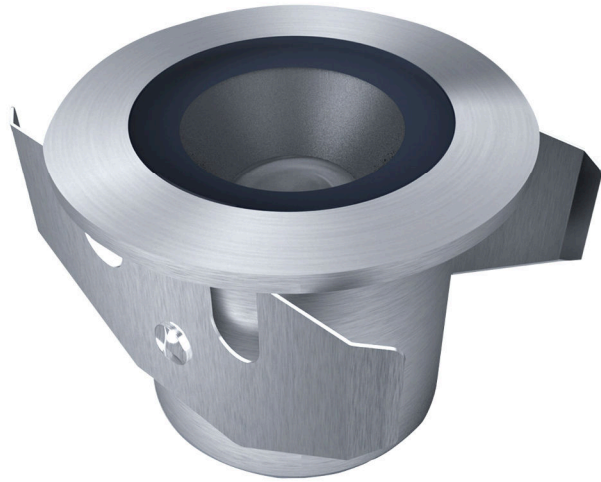

TS116  
Optional accessories

■ GL116H

Miniature recessed fixture complete with integral CREE LED Package and 20/60 degree beam options . Tempered glass ,Marine grade 316 Stainless Steel option with construction Rated to IP68 Recessed light source and black baffle serve to Minimize glare.Product footprint of 60mm diameter ensures versatile application.Inline driver options include switched,1-10V and DALI dimmable solutions .

DESCRIPTION

LED Light source	High Power LED
Light Color	CW,WW,NW,Red,Green,Blue,Amber
Material	SUS316
Optics	S20° / F60°
Power	1W
Power supply	N/A
Dimention	D60x45
Weight	465g
IP Rating	IP68
Approvals	CE,RoHS,IP
Ambient temperature	-20°C ~ +45°C
Average life	50,000Hrs
Accessories(Optional)	Yes
Applications	Indoor/Outdoor/Landscape/Submersible

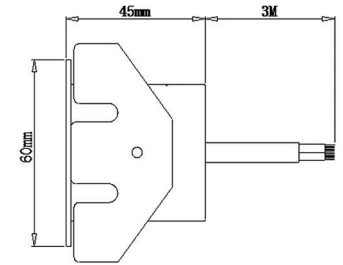

Model No.	LED Brand	Color	Beam	PowerMode	Input	Wiring	Cable	Power	Luminous Flux	Dimention	DrillSize
GL116H	CREE	CW,WW, NW,Red Green,Blue,Amber	S20/F60	Constant current	350mA	Series	3M 2X0.75mm <sup>2</sup> Cable	1W	100LM	D60X45	D50
GL116HD	CREE	CW,WW, NW,Red Green,Blue,Amber	S20/F60	Constant voltage	24VDC	Parallel	3M 2X0.75mm <sup>2</sup> Cable	1.3W	100LM	D60X45	D50

\*IES Data support.

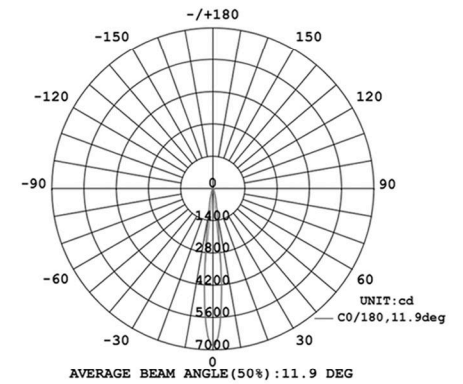
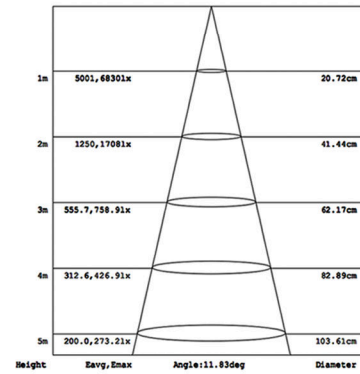

LED Colours

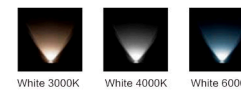



■ GL116Q

Miniature recessed fixture complete with integral CREE LED Package and S25X45/F20X50 degree beam options. Tempered glass ,marine grade 316 Stainless Steel option with construction Rated to IP68 Recessed light source and black baffle serve to minimize glare.Product footprint of 60mm diameter ensures versatile application . Inline driver options include switched,1-10V and DALI dimmable solutions.Side-entry option also available.

DESCRIPTION

<b>LED Light source</b>	High Power LED
<b>Light Color</b>	CW,WW,NW,Red,Green,Blue,Amber
<b>Material</b>	SUS316
<b>Optics</b>	S25X40° / F20X50°
<b>Power</b>	1W
<b>Power supply</b>	N/A
<b>Dimension</b>	D60x45
<b>Weight</b>	465g
<b>IP Rating</b>	IP68
<b>Approvals</b>	CE,RoHS,IP
<b>Ambient temperature</b>	-20°C ~ +45°C
<b>Average life</b>	50,000Hrs
<b>Accessories(Optional)</b>	Yes
<b>Applications</b>	Indoor/Outdoor/Landscape/Submersible

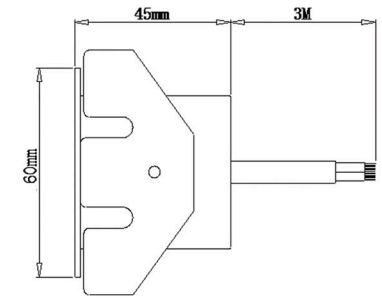

Model No.	LED Brand	Color	Beam	PowerMode	Input	Wiring	Cable	Power	Luminous Flux	Dimension	DrillSize
GL116Q	CREE	CW,WW, NW,Red Green,Blue,Amber	S25X40/F20X50	Constant current	350mA	Series	3M 2X0.75mm² Cable	1W	100LM	D60X45	D50
GL116QD	CREE	CW,WW, NW,Red Green,Blue,Amber	S25X40/F20X50	Constant voltage	24VDC	Parallel	3M 2X0.75mm² Cable	1.3W	100LM	D60X45	D50

\*IES Data support.

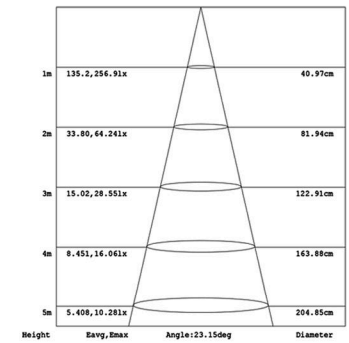
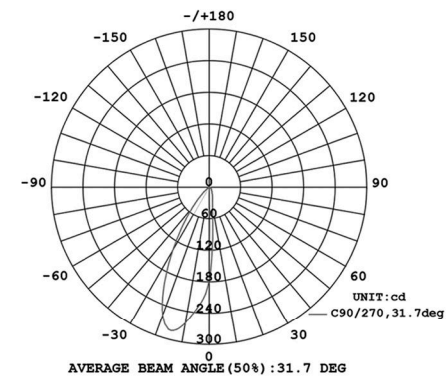
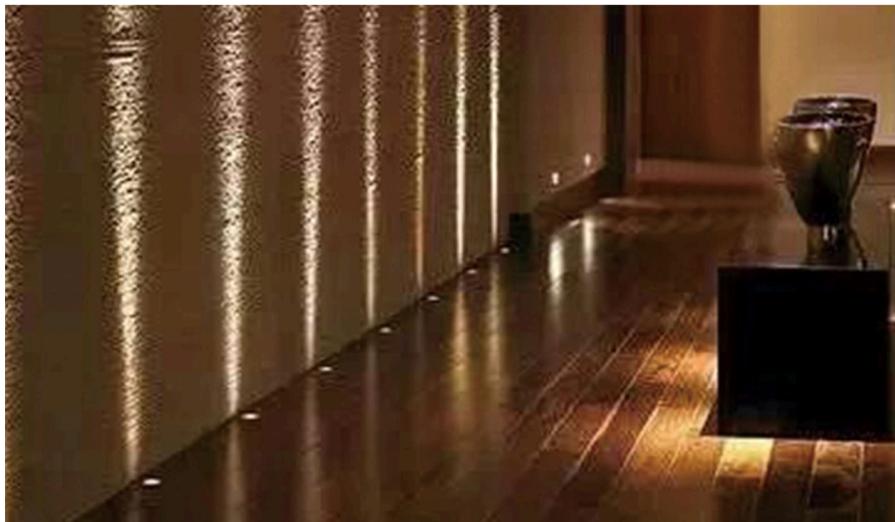

LED Colours

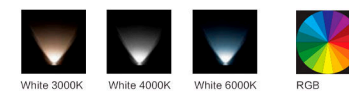

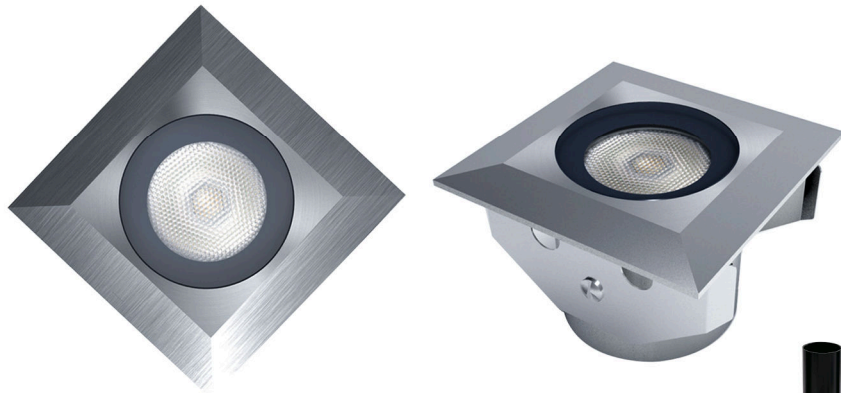

TS116  
Optional accessories

■ GL116SQ

Square recessed fixture complete with integral CREE LED package and 12/45 degree beam options. Tempered glass, marine grade 316 Stainless Steel option with construction rated to IP68. Small Product footprint ensures versatile application. Inline driver options include switched, 1-10V and DALI dimmable solutions.



DESCRIPTION

<b>LED Light source</b>	High Power LED
<b>Light Color</b>	RGB,CW,WW,NW,Red,Green,Blue,Amber
<b>Material</b>	SUS316
<b>Optics</b>	S12° / F45°
<b>Power</b>	1W
<b>Power supply</b>	N/A
<b>Dimension</b>	65x65x45
<b>Weight</b>	490g
<b>IP Rating</b>	IP68
<b>Approvals</b>	CE,RoHS,IP
<b>Ambient temperature</b>	-20°C ~ +45°C
<b>Average life</b>	50,000Hrs
<b>Accessories(Optional)</b>	Yes
<b>Applications</b>	Indoor/Outdoor/Landscape/Submersible

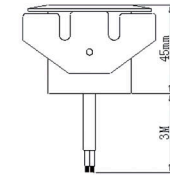
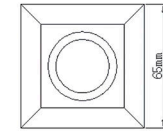

Model No.	LED Brand	Color	Beam	PowerMode	Input	Wiring	Cable	Power	Luminous Flux	Dimension	DrillSize
GL116SQ	CREE	CW,WW,NW,Red,Green,Blue,Amber	S12/F45	Constant current	350mA	Series	3M 2X0.75mm <sup>2</sup> Cable	1W	100LM	65x65x45	D50
GL116SQD	CREE	CW,WW,NW,Red,Green,Blue,Amber	S12/F45	Constant voltage	24VDC	Parallel	3M 2X0.75mm <sup>2</sup> Cable	1.3W	100LM	65x65x45	D50
GL116SQ-RGB	Edison	RGB	45	Constant current	350mA	Series	2x3M 4X0.5mm <sup>2</sup> Cable	3W	N/A	65x65x45	D50
GL116SQ-DMX-RGB	Edison	RGB	S12/F45	Constant voltage	24VDC DMX Controller	Parallel	1.1M 4X0.5mm <sup>2</sup> Cable	3.5W	N/A	65x65x45	D50

DMX decoder in built

\*IES Data support.

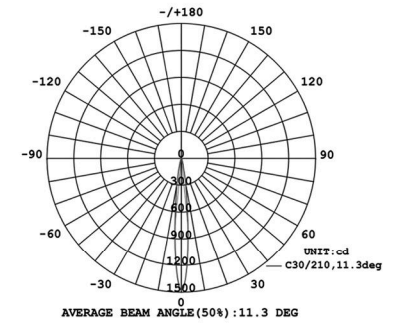
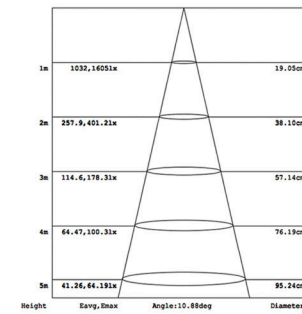

LED Colours

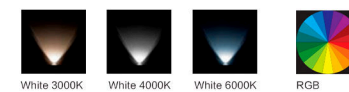



■ GL118

Miniature recessed fixture complete with integral CREE LED package. Tempered glass ,frosted optic serves to minimize glare coupled with a diffuse beam distribution. Marine Grade 316 Stainless Steel option with construction rated to IP68. Product footprint of 36mm diameter ensures versatile application.



DESCRIPTION

<b>LED Light source</b>	LED
<b>Light Color</b>	RGB,CW,WW,NW,Red,Green,Blue,Amber
<b>Material</b>	SUS316 / Brass
<b>Optics</b>	120°
<b>Power</b>	1W
<b>Power supply</b>	N/A
<b>Dimension</b>	D36X37
<b>Weight</b>	260g
<b>IP Rating</b>	IP68
<b>Approvals</b>	CE,RoHS,IP
<b>Ambient temperature</b>	-20°C ~ +45°C
<b>Average life</b>	50,000Hrs
<b>Accessories(Optional)</b>	Yes
<b>Applications</b>	Indoor/Outdoor/Landscape/Submersible

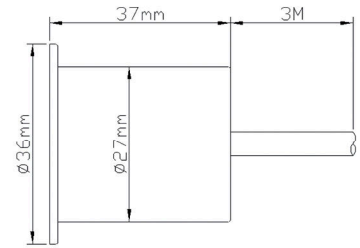

MODEL NO.	LED Brand	Color	BEAM	PowerMode	Input	Wiring	Cable	Power	Luminous Flux	Dimension	DrillSize	Material
GL118	OSRAM	CW,WW, NW,Red Green,Blue,Amber	120	Constant voltage	12/24VDC	Parallel	3M 2X0.75mm2 Cable	1W	20LM	D36X37	D29	SUS316
GL118AB	OSRAM	CW,WW, NW,Red Green,Blue,Amber	120	Constant voltage	12/24VDC	Parallel	3M 2X0.75mm2 Cable	1W	20LM	D36X37	D29	Brass
GL118RGB	EDISON	RGB	120	Constant voltage	RGB24VDC	Parallel	1.1M 4X24AWG Cable	1W	N/A	D36X37	D29	SUS316
GL118AB RGB	EDISON	RGB	120	Constant voltage	RGB24VDC	Parallel	1.1M 4X24AWG Cable	1W	N/A	D36X37	D29	Brass

\*IES Data support.

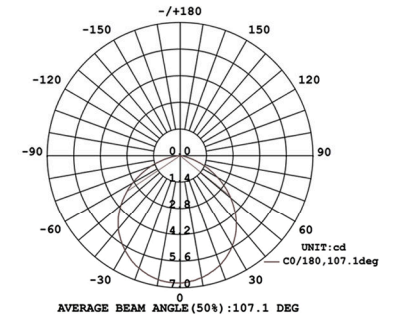
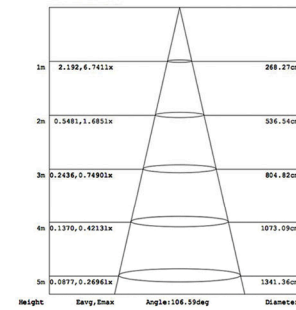

LED Colours

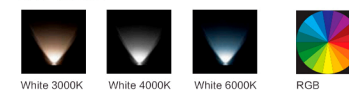



DESCRIPTION

<b>LED Light source</b>	LED
<b>Light Color</b>	RGB,CW,WW,NW,Red,Green,Blue,Amber
<b>Material</b>	SUS316 / Brass
<b>Optics</b>	120°
<b>Power</b>	1W
<b>Power supply</b>	N/A
<b>Dimension</b>	D36X37
<b>Weight</b>	280g
<b>IP Rating</b>	IP68
<b>Approvals</b>	CE,RoHS,IP
<b>Ambient temperature</b>	-20°C ~ +45°C
<b>Average life</b>	50,000Hrs
<b>Accessories(Optional)</b>	Yes
<b>Applications</b>	Indoor/Outdoor/Landscape/Submersible

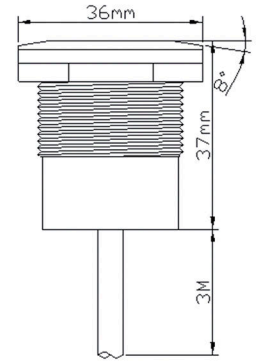

GL118T

Miniature recessed fixture complete with integral CREE LED package. Tempered glass, frosted optic serves to minimize glare coupled with a diffuse beam distribution. Marine Grade 316 Stainless Steel option with construction rated to IP68. Bronze option. Product footprint of 36mm diameter ensures versatile application.

MODEL NO.	LED Brand	Color	BEAM	PowerMode	Input	Wiring	Cable	Power	Luminous Flux	Dimension	DrillSize	Material
GL118T	OSRAM	CW,WW, NW,Red,Green,Blue,Amber	120	Constant voltage	12/24VDC	Parallel	3M 2X0.75mm <sup>2</sup> Cable	1W	20LM	D36X37	D29	SUS316
GL118TAB	OSRAM	CW,WW, NW,Red,Green,Blue,Amber	120	Constant voltage	12/24VDC	Parallel	3M 2X0.75mm <sup>2</sup> Cable	1W	20LM	D36X37	D29	Brass
GL118TRGB	Edison	RGB	120	Constant voltage	RGB24VDC	Parallel	1.1M 4X24AWG Cable	1W	N/A	D36X37	D29	SUS316
GL118TAB RGB	Edison	RGB	120	Constant voltage	RGB24VDC	Parallel	1.1M 4X24AWG Cable	1W	N/A	D36X37	D29	Brass

\*IES Data support.

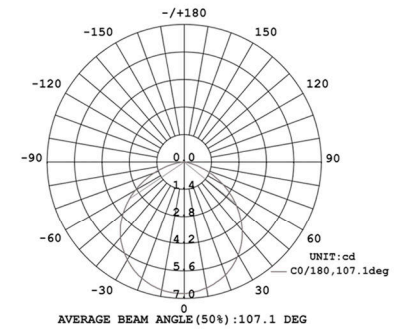
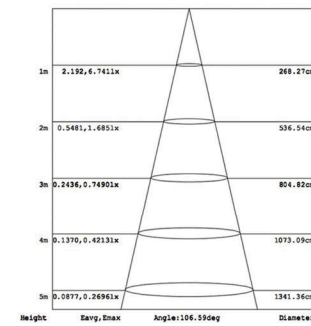
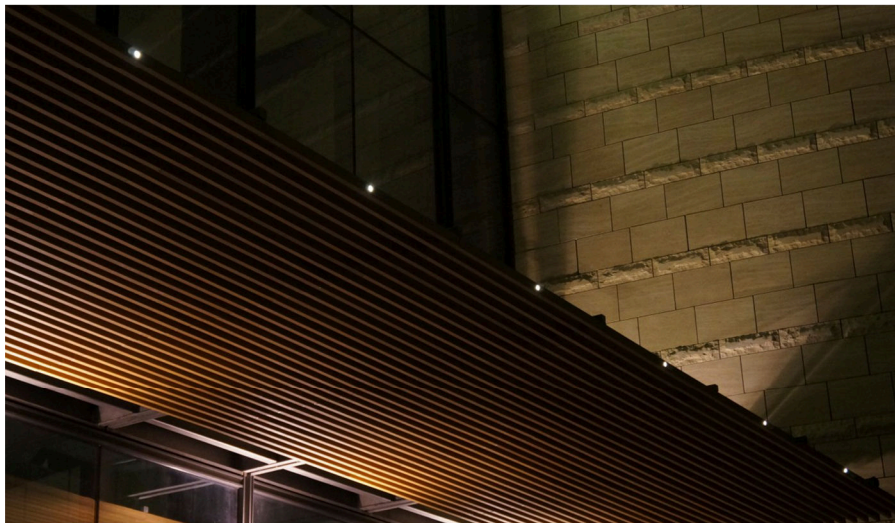

LED Colours

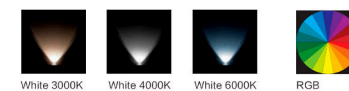



TS119

Optional accessories

■ GL119

Miniature recessed fixture complete with integral CREE LED package. Tempered glass, marine grade 316 Stainless Steel. Option with construction rated to IP68. Product footprint of 40mm diameter ensures versatile application. Inline driver options include switched, 1-10V and DALI dimmable solutions.

DESCRIPTION

<b>LED Light source</b>	High Power LED
<b>Light Color</b>	CW, WW, NW, Red, Green, Blue, Amber
<b>Material</b>	SUS316
<b>Optics</b>	S20° / F60°
<b>Power</b>	1W
<b>Power supply</b>	N/A
<b>Dimension</b>	D40X40
<b>Weight</b>	140g
<b>IP Rating</b>	IP68
<b>Approvals</b>	CE, RoHS, IP
<b>Ambient temperature</b>	-20°C ~ +45°C
<b>Average life</b>	50,000Hrs
<b>Accessories(Optional)</b>	Yes
<b>Applications</b>	Indoor/Outdoor/Landscape/Submersible

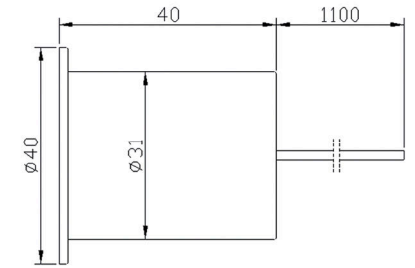

Model No.	LED Brand	Color	Beam	PowerMode	Input	Wiring	Cable	Power	Luminous Flux	Dimension	DrillSize
GL119	CREE	CW, WW, NW, Red, Green, Blue, Amber	S20/F60	Constant current	350mA	Series	1.1M 2X0.4mm <sup>2</sup> Cable	1W	100LM	D40X40	D33
GL119D	CREE	CW, WW, NW, Red, Green, Blue, Amber	S20/F60	Constant voltage	24VDC	Parallel	1.1M 2X0.4mm <sup>2</sup> Cable	1.3W	100LM	D40X40	D33

\*IES Data support.

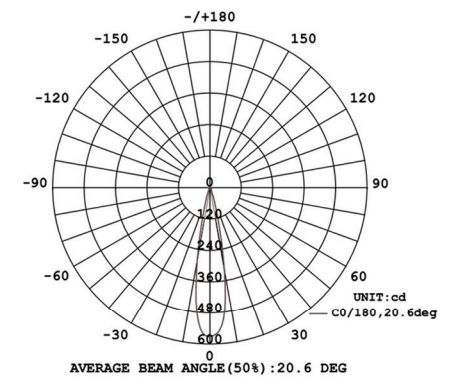
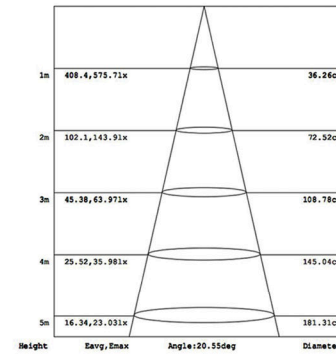
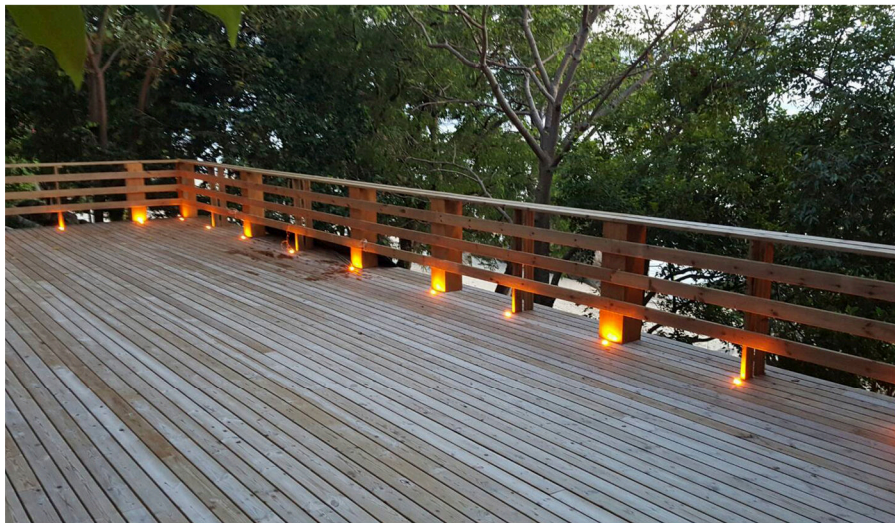

LED Colours

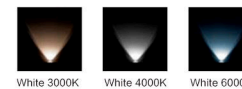



TS119T  
Optional accessories

DESCRIPTION

<b>LED Light source</b>	High Power LED
<b>Light Color</b>	CW,WW,NW,Red,Green,Blue,Amber
<b>Material</b>	SUS316
<b>Optics</b>	S20° / F60°
<b>Power</b>	1W
<b>Power supply</b>	N/A
<b>Dimension</b>	D40X40
<b>Weight</b>	150g
<b>IP Rating</b>	IP68
<b>Approvals</b>	CE,RoHS,IP
<b>Ambient temperature</b>	-20°C ~ +45°C
<b>Average life</b>	50,000Hrs
<b>Accessories(Optional)</b>	Yes
<b>Applications</b>	Indoor / Outdoor / Landscape / Submersible

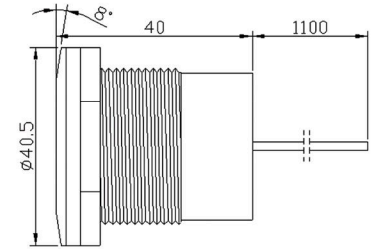

■ GL119T

Miniature recessed fixture complete with integral CREE LED package. Tempered glass, marine grade 316 Stainless Steel Option with construction rated to IP68. Product footprint of 40mm diameter ensures versatile application. In-line driver options include switched, 1-10V and DALI dimmable solutions.

Model No.	LED Brand	Color	Beam	Power Mode	Input	Wiring	Cable	Power	Luminous Flux	Dimension	Drill Size
GL119T	CREE	CW,WW, NW,Red Green,Blue, Amber	S20/F60	Constant current	350mA	Series	1.1M 2X0.4mm <sup>2</sup> Cable	1W	100LM	D40X40	D33
GL119TD	CREE	CW,WW, NW,Red Green,Blue, Amber	S20/F60	Constant voltage	24VDC	Parallel	1.1M 2X0.4mm <sup>2</sup> Cable	1.3W	100LM	D40X40	D33

\*IES Data support.

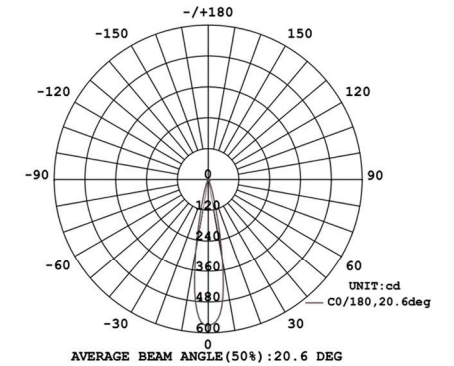
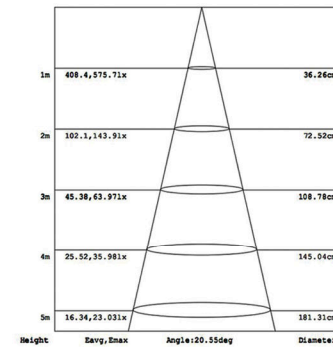
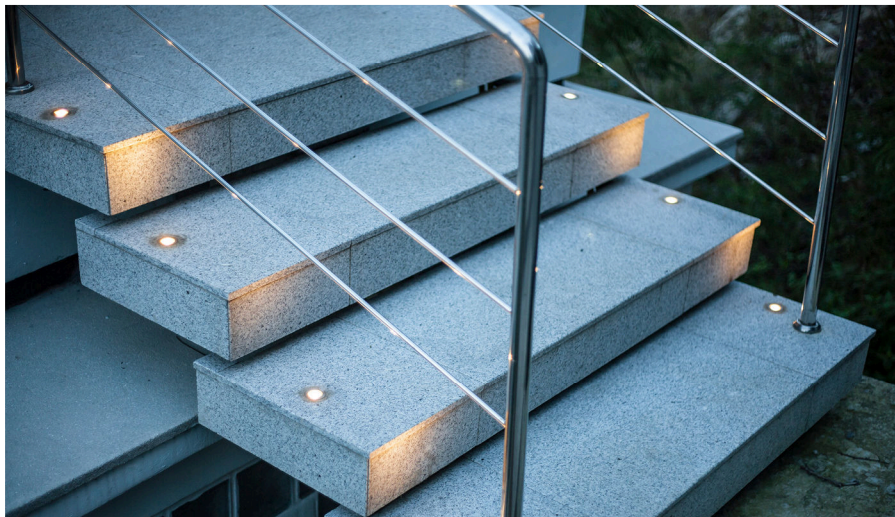

LED Colours

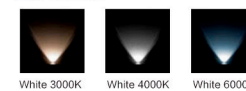



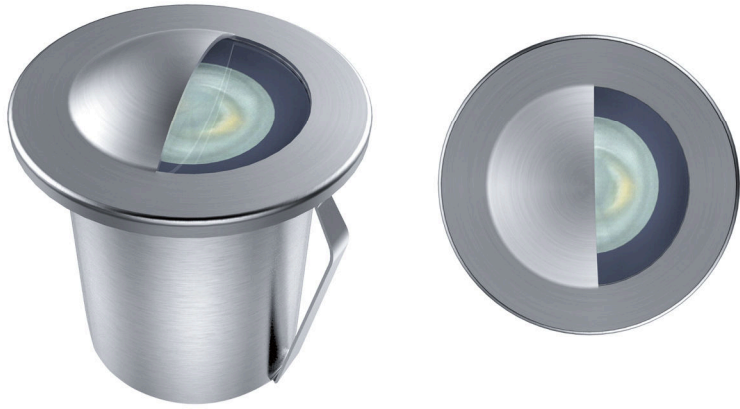

■ GL119CT

Miniature Eye-Lid fixture complete with integral CREE LED package And 20/60 degree beam options. Tempered glass, marine grade 316 Stainless Steel option with construction rated to IP68 with Eye-Lid Design for asymmetric light emission. Product footprint of 41.5mmdiameter ensures versatile application. Inline driver options include switched, 1-10V and DALI dimmable solutions.

DESCRIPTION

<b>LED Light source</b>	High Power LED
<b>Light Color</b>	CW, WW, NW, Red, Green, Blue, Amber
<b>Material</b>	SUS316
<b>Optics</b>	S20° / F60°
<b>Power</b>	1W
<b>Power supply</b>	N/A
<b>Dimension</b>	D41.5X48
<b>Weight</b>	140g
<b>IP Rating</b>	IP68
<b>Approvals</b>	CE, RoHS, IP
<b>Ambient temperature</b>	-20°C ~ +45°C
<b>Average life</b>	50,000Hrs
<b>Accessories(Optional).</b>	Yes
<b>Applications</b>	Indoor/Outdoor/Landscape/Submersible

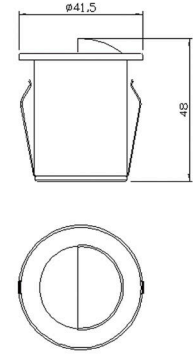

Model No.	LED Brand	Color	Beam	PowerMode	Input	Wiring	Cable	Power	Luminous Flux	Dimension	DrillSize
GL119CT	CREE	CW, WW, NW, Red, Green, Blue, Amber	S20/F60	Constant current	350mA	Series	1.1M 2X0.4mm <sup>2</sup> Cable	1W	100LM	D41.5X48	D33
GL119CTD	CREE	CW, WW, NW, Red, Green, Blue, Amber	S20/F60	Constant voltage	24VDC	Parallel	1.1M 2X0.4mm <sup>2</sup> Cable	1.3W	100LM	D41.5X48	D33

\*IES Data support.

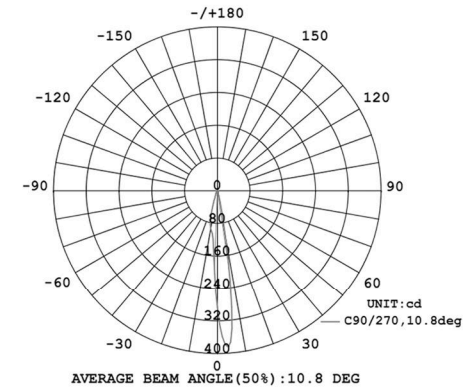
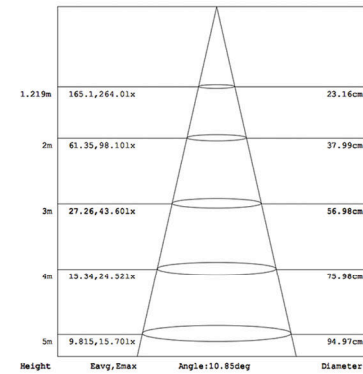
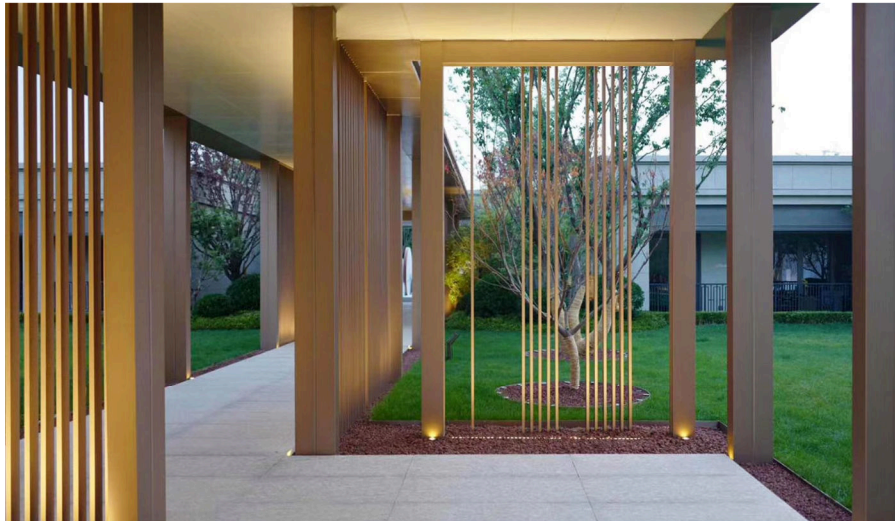

LED Colours

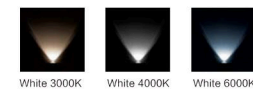

DESCRIPTION

<b>LED Light source</b>	High Power LED
<b>Light Color</b>	CW,WW,NW,Red,Green,Blue,Amber
<b>Material</b>	SUS316
<b>Optics</b>	S20° / F60°
<b>Power</b>	1W
<b>Power supply</b>	N/A
<b>Dimension</b>	45X45X40
<b>Weight</b>	145g
<b>IP Rating</b>	IP68
<b>Approvals</b>	CE,RoHS,IP
<b>Ambient temperature</b>	-20°C ~ +45°C
<b>Average life</b>	50,000Hrs
<b>Accessories(Optional)</b>	Yes
<b>Applications</b>	Indoor/Outdoor/Landscape/Submersible

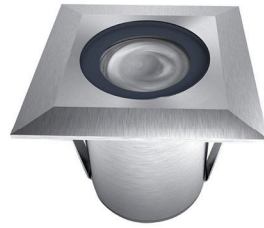
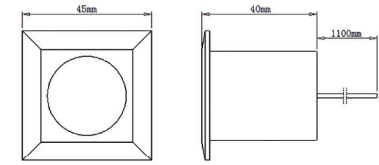

TS119  
Optional accessories

GL119SQ

Square recessed fixture complete with integral CREE LED package and 20/60 degree beam options. Tempered glass, marine grade 316 Stainless Steel option with construction rated to IP68. Small product footprint ensures versatile application. Inline driver options include switched, 1-10V and DALI dimmable solutions.

Model No.	LED Brand	Color	Beam	PowerMode	Input	Wiring	Cable	Power	Luminous	Dimension	DrillSize
GL119SQ	CREE	CW,WW, NW,Red Green,Blue,Amber	S20/F60	Constant current	350mA	Series	1.1M 2X0.4mm <sup>2</sup> Cable	1W	100LM	45X45X40	D33
GL119SQD	CREE	CW,WW, NW,Red Green,Blue,Amber	S20/F60	Constant voltage	24VDC	Parallel	1.1M 2X0.4mm <sup>2</sup> Cable	1.3W	100LM	45X45X40	D33

\*IES Data support.

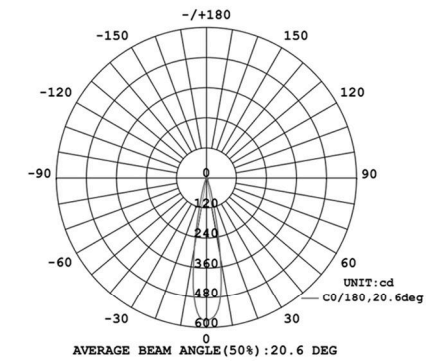
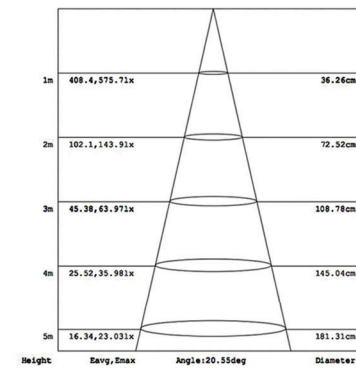
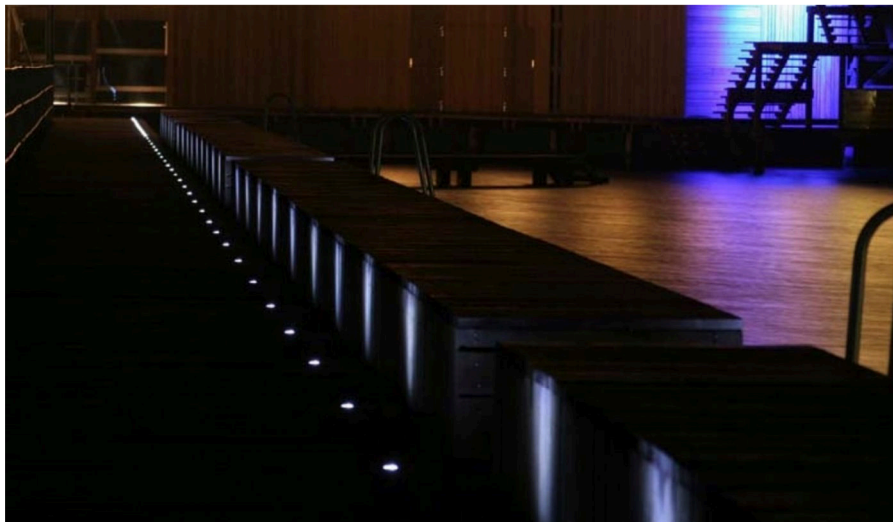

LED Colours

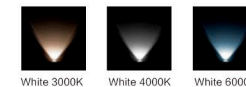



TS119  
Optional accessories

DESCRIPTION

<b>LED Light source</b>	High Power LED
<b>Light Color</b>	CW,WW,NW,Red,Green,Blue,Amber
<b>Material</b>	SUS316
<b>Optics</b>	S20° / F60°
<b>Power</b>	1W
<b>Power supply</b>	N/A
<b>Dimension</b>	D50X42
<b>Weight</b>	155g
<b>IP Rating</b>	IP68
<b>Approvals</b>	CE,RoHS,IP
<b>Ambient temperature</b>	-20°C ~ +45°C
<b>Average life</b>	50,000Hrs
<b>Accessories(Optional)</b>	Yes
<b>Applications</b>	Indoor/Outdoor/Landscape/Submersible

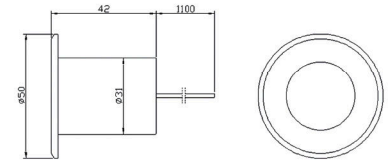

■ GL129

Miniature recessed fixture complete with integral CREE LED package. Tempered glass, marine grade 316 Stainless Steel option with construction rated to IP68. Product footprint of 50mm diameter ensures versatile application. In-line driver options include switched, 1-10V and DALI dimmable solutions.

Model No.	LED Brand	Color	Beam	PowerMode	Input	Wiring	Cable	Power	Luminous Flux	Dimension	DrillSize
GL129	CREE	CW,WW, NW,Red Green,Blue,Amber	S20/F60	Constant current	350mA	Series	1.1M 2X0.4mm <sup>2</sup> Cable	1W	100LM	D50X42	D33
GL129D	CREE	CW,WW, NW,Red Green,Blue,Amber	S20/F60	Constant voltage	24VDC	Parallel	1.1M 2X0.4mm <sup>2</sup> Cable	1.3W	100LM	D50X42	D33

\*IES Data support.

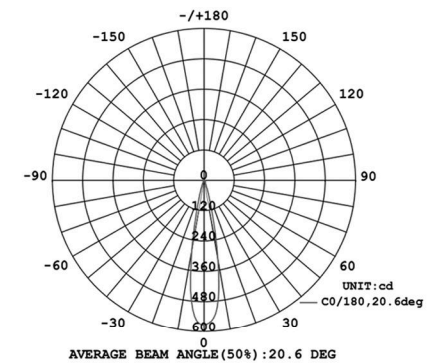
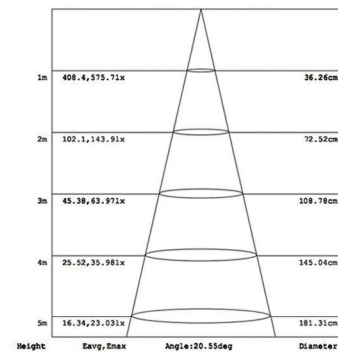
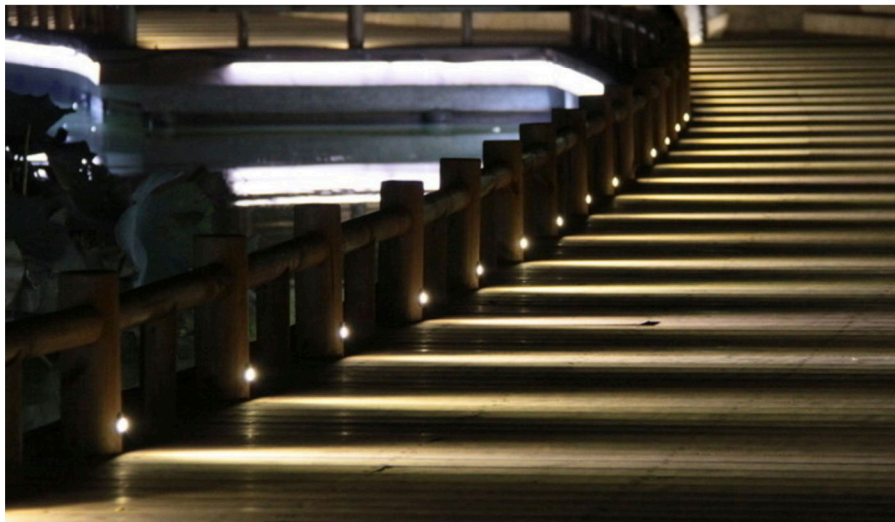

LED Colours

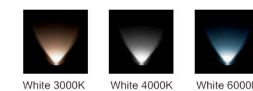

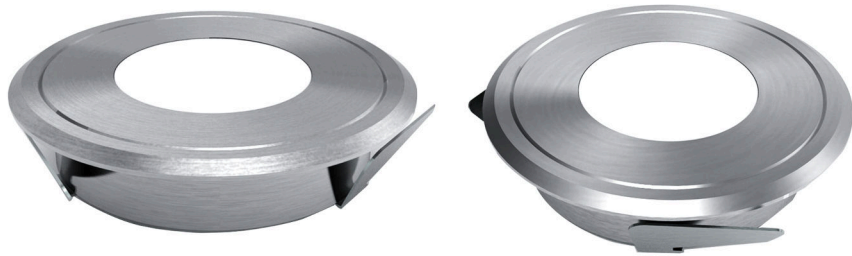

DESCRIPTION

<b>LED Light source</b>	High Power LED
<b>Light Color</b>	CW,WW,NW,Red,Green,Blue,Amber
<b>Material</b>	SUS316
<b>Optics</b>	120°
<b>Power</b>	1W
<b>Power supply</b>	N/A
<b>Dimension</b>	D45X12
<b>Weight</b>	70g
<b>IP Rating</b>	IP68
<b>Approvals</b>	CE,RoHS,IP
<b>Ambient temperature</b>	-20°C ~ +45°C
<b>Average life</b>	50,000Hrs
<b>Accessories(Optional)</b>	N/A
<b>Applications</b>	Indoor/Outdoor/Landscape/Submersible

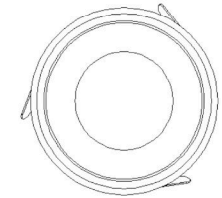
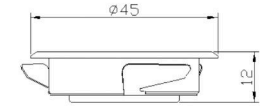

■ GL108

Marine Grade 316 Stainless Steel option with construction rated to IP68.Tempered glass with 120 degree beam option .It is designed to add style to floors ,bars ,walls and ceilings.The clever and stylish design of the light output means no glare even when looking directly at it ,making this product perfect for stair facings .Installation will be Quick and easy.

Model No.	LED Brand	Color	Beam	PowerMode	Input	Wiring	Cable	Power	Luminous Flux	Dimension	DrillSize
GL108	CREE	CW,WW, NW,Red Green,Blue,Amber	120	Constant current	350mA	Series	1.1M 2X0.4mm <sup>2</sup> Cable	1W	75LM	D45X12	D38

\*IES Data support.

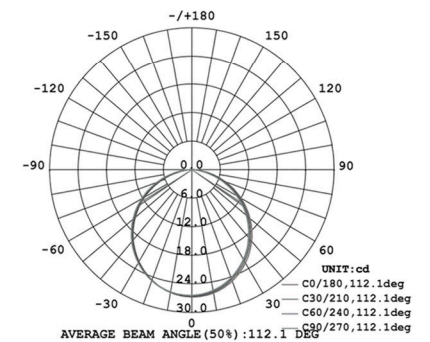
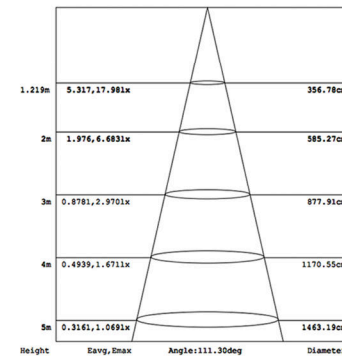
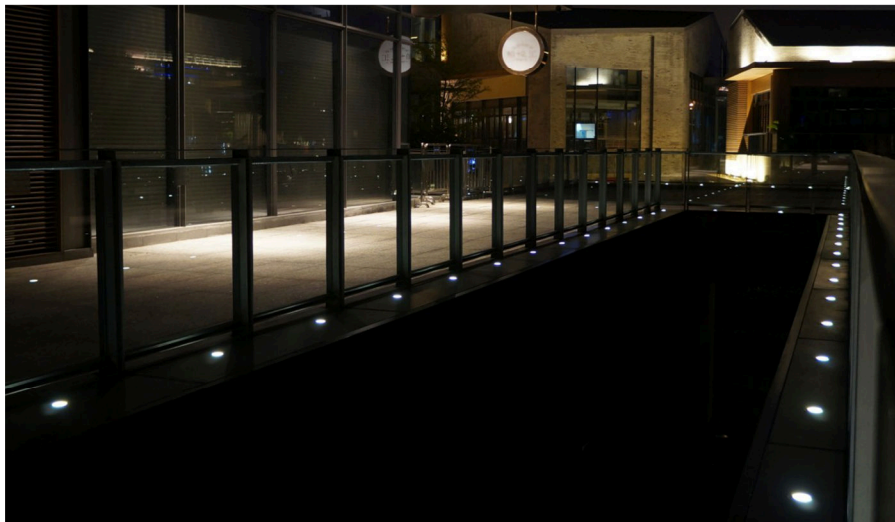

LED Colours

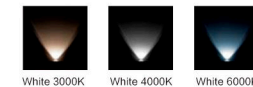



DESCRIPTION

<b>LED Light source</b>	LED
<b>Light Color</b>	RGB,CW,WW,NW,Red,Green,Blue,Amber
<b>Material</b>	SUS316
<b>Optics</b>	120°
<b>Power</b>	1W
<b>Power supply</b>	N/A
<b>Dimension</b>	D45X12
<b>Weight</b>	75g
<b>IP Rating</b>	IP68
<b>Approvals</b>	CE,RoHS,IP
<b>Ambient temperature</b>	-20°C ~ +45°C
<b>Average life</b>	50,000Hrs
<b>Accessories(Optional)</b>	N/A
<b>Applications</b>	Indoor/Outdoor/Landscape/Submersible

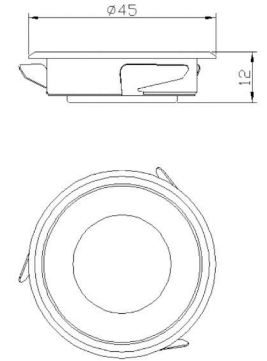

■ GL308

Marine Grade 316 Stainless Steel option with construction rated to IP68. Tempered glass with 120 degree beam option .It is designed to add style to floors,bars,walls and ceilings.The clever and stylish design of the light output means no glare even when looking directly at it,making this product perfect for stair facings.Installation will be quick and easy.

Model No.	LED Brand	Color	Beam	PowerMode	Input	Wiring	Cable	Power	Luminous Flux	Dimension	DrillSize
GL308	OSRAM	CW,WW, NW,Red Green,Blue,Amber	120	Constant voltage	12/24VDC	Parallel	1.1M 2X0.4 Cable	1W	20LM	D45X12	D38
GL308RGB	EDISON	RGB	120	Constant voltage	24VDC	Parallel	1.1M 4X24AWG Cable	1W	N/A	D45X12	D38

\*IES Data support.

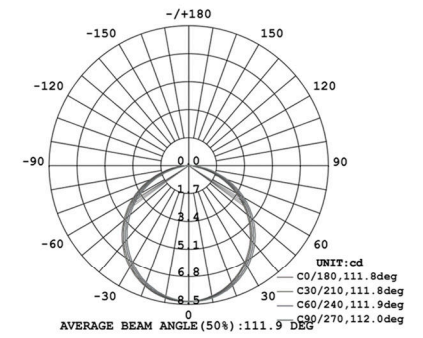
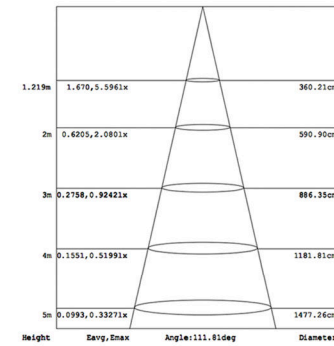
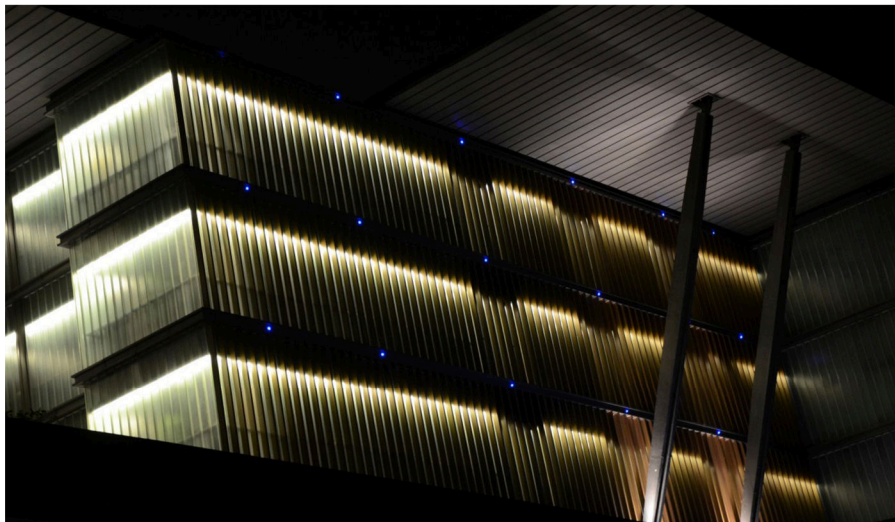

LED Colours

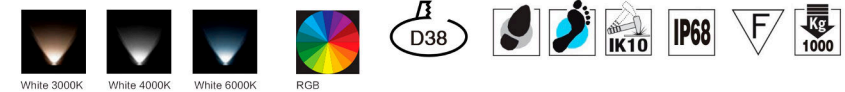



GL117AL

GL117-1W

■ GL117

Tempered glass,marine grade 316 stainless steel bezel panel with aluminum lamp body.integral CREE LED package .Product Footprint of 60mm diameter ensures versatile application.10/45 degree beam as standard,product functions with 350 mA constant current driver.Inline driver options include switched 1-10Vand DALI dimmable solutions.

DESCRIPTION

<b>LED Light source</b>	High Power LED
<b>Light Color</b>	CW,WW,NW,Red,Green,Blue,Amber
<b>Material</b>	SUS316(Lamp cap)+Aluminum(Lamp cup)
<b>Optics</b>	10° / S20° / 45° / F60°
<b>Power</b>	3W
<b>Power supply</b>	N/A
<b>Dimension</b>	D60X50
<b>Weight</b>	N/A
<b>IP Rating</b>	IP67
<b>Approvals</b>	CE,RoHS,IP
<b>Ambient temperature</b>	-20°C ~ +45°C
<b>Average life</b>	50,000Hrs
<b>Accessories(Optional)</b>	N/A
<b>Applications</b>	Indoor/Outdoor

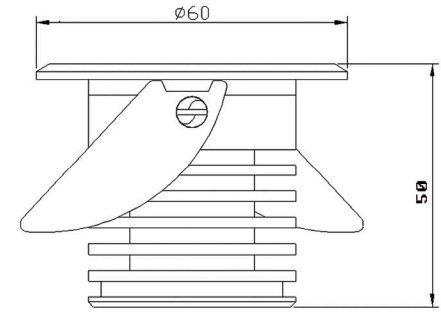

Model No.	LED Brand	Color	Beam	PowerMode	Input	Wiring	Cable	Power	Luminous Flux	Dimension	DrillSize
GL117	CREE	CW,WW, NW,Red Green,Blue,Amber	10/S20/45/F60	Constant current	350mA	Series	1.1M 2X0.4mm² Cable	3W	220LM	D60X50	D50
GL117D	CREE	CW,WW, NW,Red Green,Blue,Amber	10/S20/45/F60	Constant voltage	24VDC	Parallel	1.1M 2X0.4mm² Cable	3.5W	220LM	D60X50	D50
GL117DMX	CREE	CW,WW, NW,Red Green,Blue,Amber	10/S20/45/F60	Constant voltage	DMX24VDC	Parallel	1.1M 5X0.5mm² Cable	3.5W	220LM	D60X50	D50

DMX decoder in built

\*IES Data support.

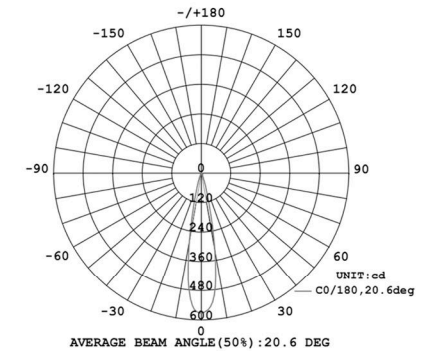
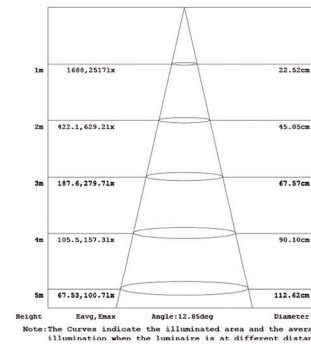

LED Colours

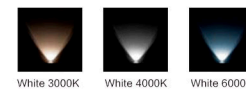



DESCRIPTION

<b>LED Light source</b>	High Power LED
<b>Light Color</b>	RGB,CW,WW,NW,Red,Green,Blue,Amber,RGB
<b>Material</b>	SUS316(Lamp cap)+Aluminum(Lamp cup)
<b>Optics</b>	S20° / F60°
<b>Power</b>	3W
<b>Power supply</b>	N/A
<b>Dimension</b>	D98X160
<b>Weight</b>	930g
<b>IP Rating</b>	IP67
<b>Approvals</b>	CE,RoHS,IP
<b>Ambient temperature</b>	-20°C ~ +45°C
<b>Average life</b>	50,000Hrs
<b>Accessories(Optional)</b>	Yes
<b>Applications</b>	Indoor/Outdoor/Landscape

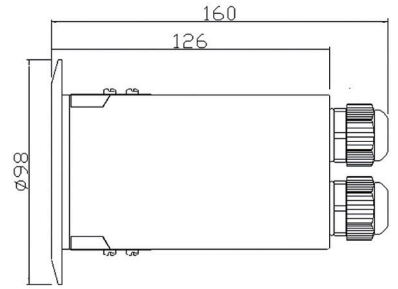

GL130

Tempered glass,marine grade 316 stainless steel bezel panel with Aluminum lamp body.Hidden&embedded design installation .This fixture complete with integral CREE LED package.Fixture rated to IP67.

Model No.	LED Brand	Color	Beam	PowerMode	Input	Wiring	Cable	Power	Luminous Flux	Dimension	DrillSize
GL130	CREE	CW,WW, NW,Red,Green,Blue,Amber	S20/F60	Constant voltage	100-240VAC	Parallel	N/A	3W	250LM	D98X160	D74
GL130D	CREE	CW,WW, NW,Red,Green,Blue,Amber	S20/F60	Constant voltage	24VDC	Parallel	N/A	3W	250LM	D98X160	D74
GL130RGB	CREE	RGB	45	Constant current	350mA	Series	N/A	3W	N/A	D98X160	D74

\*IES Data support.

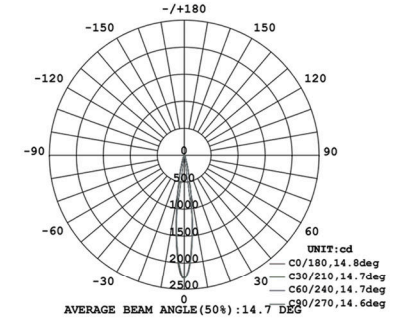
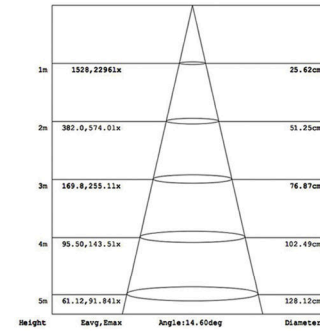
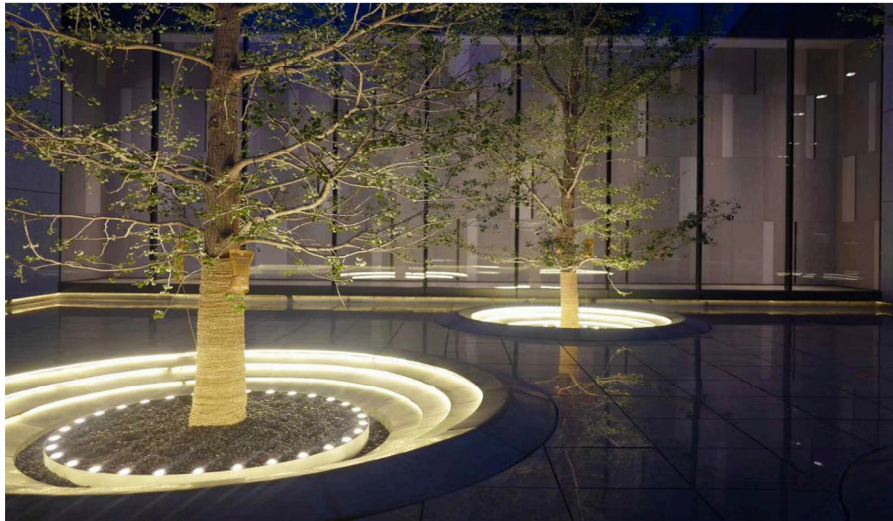

LED Colours

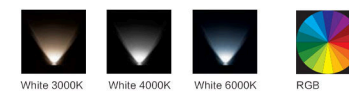



GL140

Miniature recessed fixture complete with integral CREE LED package and 10/20/30/45/60 degree beam options. Tempered glass, marine grade 316 Stainless Steel option with construction rated to IP68. Product footprint of 76mm diameter ensures versatile application. Inline driver options include switched, 1-10V and DALI dimmable solutions.

DESCRIPTION

LED Light source	High Power LED
Light Color	RGB,CW,WW,NW,Red,Green,Blue,Amber
Material	SUS316 / Brass
Optics	10/S20/30/45/F60
Power	3W
Power supply	N/A
Weight	N/A
IP Rating	IP68
Approvals	CE,RoHS,IP
Ambient temperature	-20°C ~ +45°C
Average life	50,000Hrs
Accessories(Optional)	Yes
Applications	Indoor/Outdoor/Landscape/Submersible

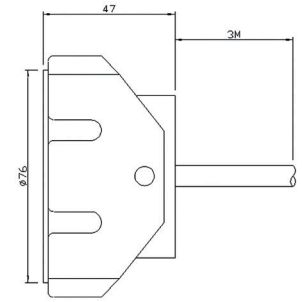

Model No.	LED Brand	Color	Beam	PowerMode	Input	Wiring	Cable	Power	Luminous Flux	Dimension	DrillSize
GL140	CREE	CW,WW, NW,Red,Green,Blue,Amber	10/S20/30/45/F60	Constant current	350mA	Series	3M 2X0.75mm <sup>2</sup> Cable	3W	300LM	D76X47	D65
GL140D	CREE	CW,WW, NW,Red,Green,Blue,Amber	10/S20/30/45/F60	Constant voltage	12/24VDC	Parallel	3M 2X0.75mm <sup>2</sup> Cable	3.5W	300LM	D76X47	D65
GL140RGB	CREE	R+G+B	10/S20/30/45/F60	Constant current	350mA	Series	2x3M 4X0.5mm <sup>2</sup> Cable	3W	N/A	D76X47	D65
GL140RGB-9W(IP67)	Edison	RGB	45	Constant current	350mA Controller	Series	2x3M 4X0.5mm <sup>2</sup> Cable	9W	N/A	D76X86	D65
GL140DMX-RGB	Edison	RGB(FullColor)	10/S20/30/45/F60	Constant voltage	24VDC DMX Controller	Parallel	1.1M 4X0.5mm <sup>2</sup> Cable	3.5W	N/A	D76X47	D65
GL140DMX-RGBW	Edison	RGBW(FullColor)	10/S20/30/45/F60	Constant voltage	24VDC DMX Controller	Parallel	1.1M 4X0.5mm <sup>2</sup> Cable	3.5W	N/A	D76X47	D65

DMX decoder in built

\*IES Data support.

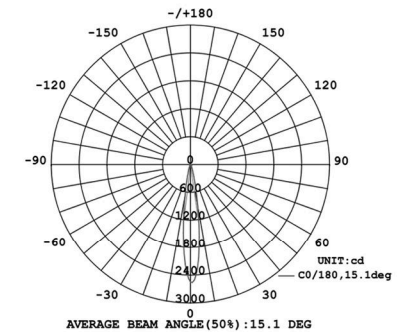
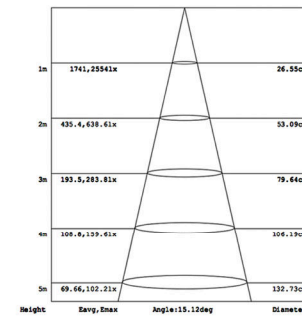

LED Colours

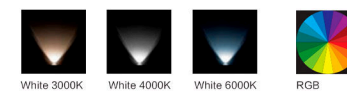



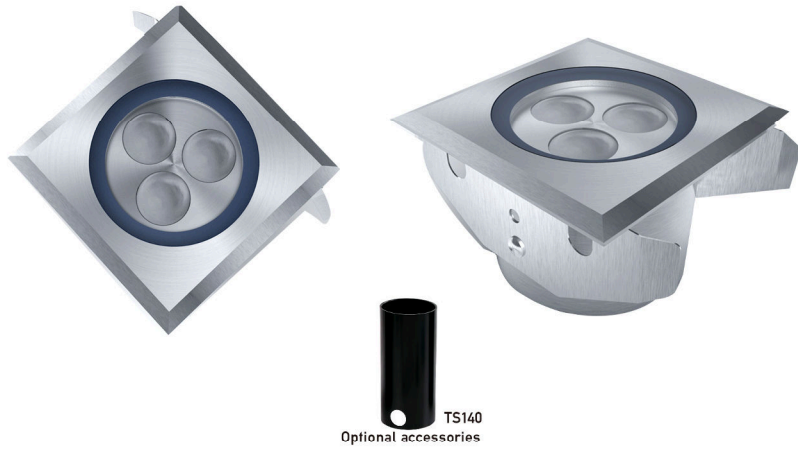

■ GL140SQ

Square recessed fixture complete with integral CREE LED package and 20/60 degree beam options. Tempered glass, marine grade 316 Stainless Steel option with construction rated to IP68. Product footprint of 76mmdiameter ensures versatile application. Inline driver options include switched, 1-10V and DALI dimmable solutions.

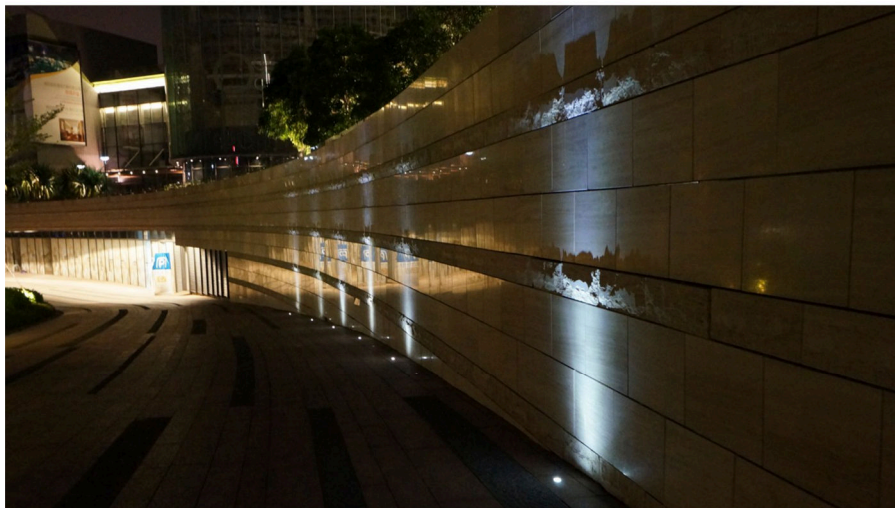

DESCRIPTION

<b>LED Light source</b>	High Power LED
<b>Light Color</b>	RGB,CW,WW,NW,Red,Green,Blue,Amber
<b>Material</b>	SUS316
<b>Optics</b>	S20° / F60°
<b>Power</b>	3W
<b>Power supply</b>	N/A
<b>Dimension</b>	76x76x47
<b>Weight</b>	N/A
<b>IP Rating</b>	IP68
<b>Approvals</b>	CE,RoHS,IP
<b>Ambient temperature</b>	-20°C ~ +45°C
<b>Average life</b>	50,000Hrs
<b>Accessories(Optional)</b>	Yes
<b>Applications</b>	Indoor/Outdoor/Landscape/Submersible

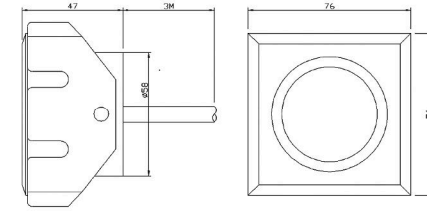

Model No.	LED Brand	Color	Beam	PowerMode	Input	Wiring	Cable	Power	Luminous Flux	Dimension	DrillSize
GL140SQ	CREE	CW,WW, NW,Red Green,Blue,Amber	S20/F60	Constant current	350mA	Series	3M 2X0.75mm <sup>2</sup> Cable	3W	300LM	76X76X47	D65
GL140SQD	CREE	CW,WW, NW,Red Green,Blue,Amber	S20/F60	Constant voltage	12/24VDC	Parallel	3M 2X0.75mm <sup>2</sup> Cable	3.5W	300LM	76X76X47	D65
GL140SQRGB	CREE	R+G+B	S20/F60	Constant current	350mA	Series	2x3M 4X0.5mm <sup>2</sup> Cable	3W	N/A	76X76X47	D65
GL140SQ-DMX-RGB	Edison	RGB(FullColor)	S20/F60	Constant voltage	24VDC DMX Controller	Parallel	1.1M 4X0.5mm <sup>2</sup> Cable	3.5W	N/A	76X76X47	D65

DMX decoder in built

\*IES Data support.

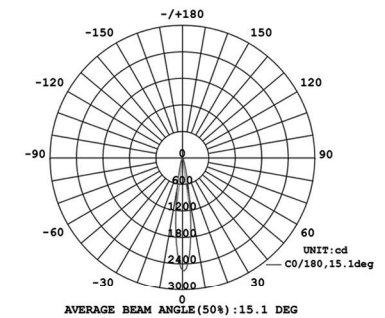
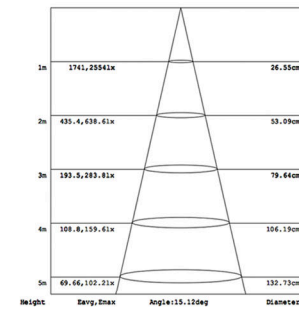

LED Colours



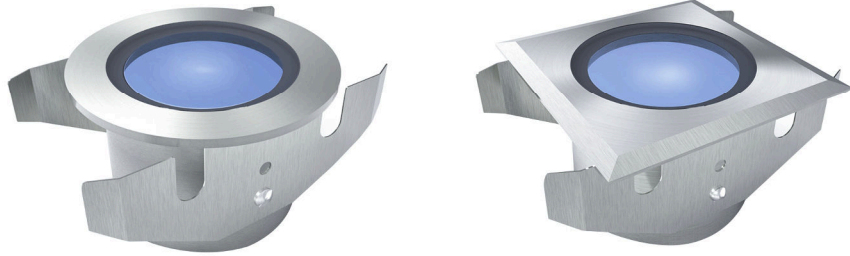

GL150SQ



■ GL150

Miniature recessed fixture complete with integral CREE LED package and 120 degree beam option. Tempered glass, marine grade 316 Stainless Steel construction rated to IP68. Product footprint of 76mm diameter ensures versatile application. Inline driver options include switched, 1-10V and DALI dimmable solutions.



DESCRIPTION

<b>LED Light source</b>	High Power LED
<b>Light Color</b>	RGB,CW,WW,NW,Red,Green,Blue,Amber
<b>Material</b>	SUS316
<b>Optics</b>	120°
<b>Power</b>	3W
<b>Power supply</b>	N/A
<b>Dimension</b>	D76X47
<b>Weight</b>	635g
<b>IP Rating</b>	IP68
<b>Approvals</b>	CE,RoHS,IP
<b>Ambient temperature</b>	-20°C ~ +45°C
<b>Average life</b>	50,000Hrs
<b>Accessories(Optional)</b>	Yes
<b>Applications</b>	Indoor/Outdoor/Landscape/Submersible

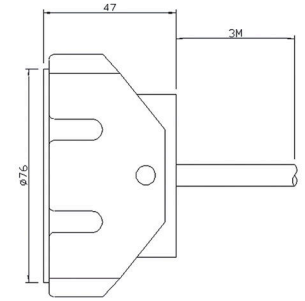

Model No.	LED Brand	Color	Beam	PowerMode	Input	Wiring	Cable	Power	Luminous Flux	Dimension	DrillSize
GL150	CREE	CW,WW, NW,Red Green,Blue,Amber	120	Constant current	350mA	Series	3M 2X0.75mm <sup>2</sup> Cable	3W	300LM	D76X47	D65
GL150D	CREE	CW,WW, NW,Red Green,Blue,Amber	120	Constant voltage	12/24VDC	Parallel	3M 2X0.75mm <sup>2</sup> Cable	3.5W	300LM	D76X47	D65
GL150SQ	CREE	CW,WW, NW,Red Green,Blue,Amber	120	Constant current	350mA	Series	3M 2X0.75mm <sup>2</sup> Cable	3W	300LM	76X76X47	D65
GL150RGB	EDISON	RGB	120	Constant current	350mA	Series	2x3M 4X0.5mm <sup>2</sup> Cable	7W	N/A	D76X47	D65
GL150DMX-RGB	EDISON	RGB	120	Constant voltage	24VDC DMX Controller	Parallel	1.1M 4X0.5mm <sup>2</sup> Cable	3.5W	N/A	D76X47	D65

DMX decoder in built

\*IES Data support.

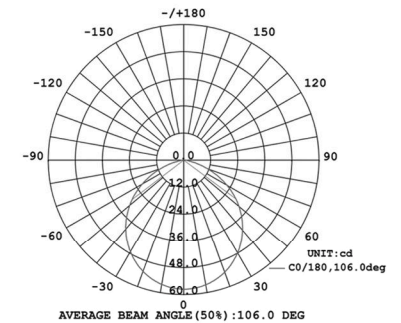
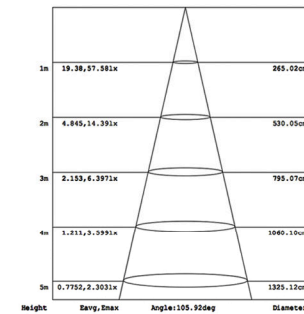

LED Colours

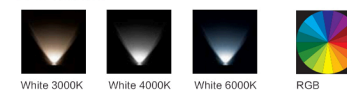

DESCRIPTION

<b>LED Light source</b>	LED
<b>Light Color</b>	RGB,CW,WW,NW,Red,Green,Blue,Amber
<b>Material</b>	SUS316
<b>Optics</b>	120°
<b>Power</b>	3W
<b>Power supply</b>	N/A
<b>Dimension</b>	D76X47
<b>Weight</b>	680g
<b>IP Rating</b>	IP68
<b>Approvals</b>	CE,RoHS,IP
<b>Ambient temperature</b>	-20°C ~ +45°C
<b>Average life</b>	50,000Hrs
<b>Accessories(Optional)</b>	Yes
<b>Applications</b>	Indoor/Outdoor/Landscape/Submersible

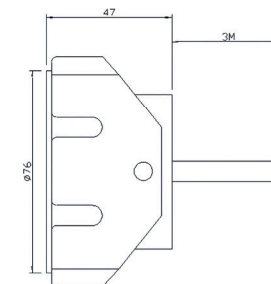

TS140  
Optional accessories

■ GL550RGB

Miniature recessed fixture complete with integral Edison LED package and 120 degree beam option. Marine Grade 316 Stainless Steel construction rated to IP68. Tempered glass. Product footprint of 76mm diameter ensures versatile application.

Model No.	LED Brand	Color	Beam	PowerMode	Input	Wiring	Cable	Power	Luminous Flux	Dimension	DrillSize
GL550RGB	EDISON	RGB	120	Constant voltage	24VDC	Parallel	3M 4X0.5mm <sup>2</sup> Cable	3W	N/A	D76X47	D65
GL550DMX-RGB	EDISON	RGB	120	Constant voltage	24VDC DMX Controller	Parallel	1.1M 4X0.5mm <sup>2</sup> Cable	3W	N/A	D76X47	D65

DMX decoder in built

\*IES Data support.

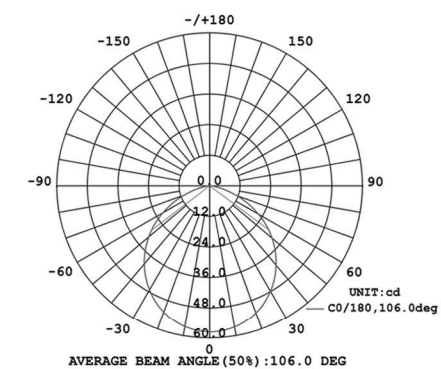
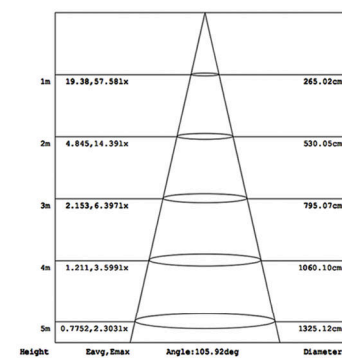
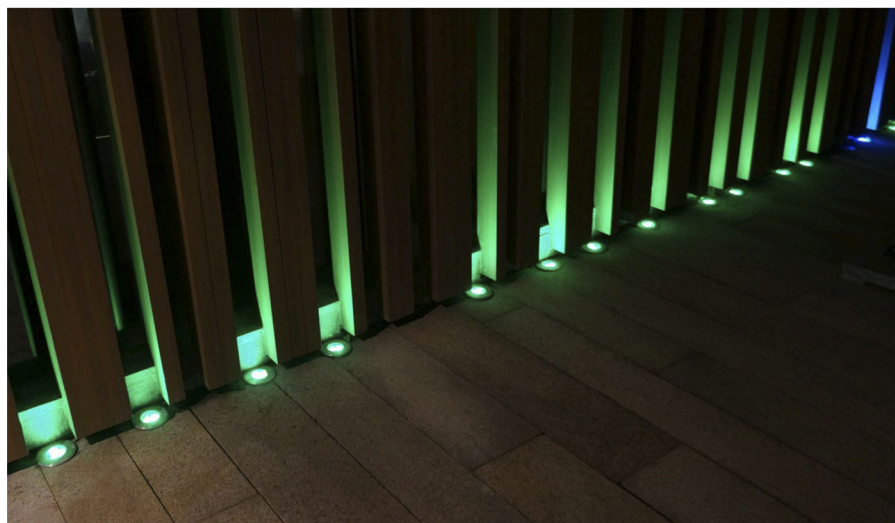



■ GL151

Marine grade 316 stainless steel in-ground single marker light complete with integral CREE LED package. Tempered glass, fixture rated to IP68 with single aperture for asymmetric emission. Product functions with 350mA constant current driver, inline driver options include switched, 1-10V and DALI dimmable solutions.



DESCRIPTION

<b>LED Light source</b>	High Power LED
<b>Light Color</b>	CW,WW,NW,Red,Green,Blue,Amber
<b>Material</b>	SUS316
<b>Optics</b>	N/A
<b>Power</b>	3W
<b>Power supply</b>	N/A
<b>Dimension</b>	D88x45
<b>Weight</b>	N/A
<b>IP Rating</b>	IP68
<b>Approvals</b>	CE, RoHS, IP
<b>Ambient temperature</b>	-20°C ~ +45°C
<b>Average life</b>	50,000Hrs
<b>Accessories(Optional)</b>	Yes
<b>Applications</b>	Indoor/Outdoor/Landscape/Submersible

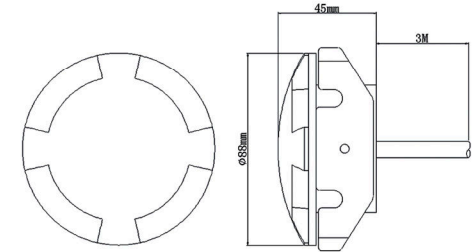

Model No.	LED Brand	Color	Beam	PowerMode	Input	Wiring	Cable	Power	Luminous Flux	Dimension	DrillSize
GL151	CREE	CW,WW, NW,Red Green,Blue,Amber	N/A	Constant current	350mA	Series	3M 2X0.75mm <sup>2</sup> Cable	3W	N/A	D88X45	D65
GL152	CREE	CW,WW, NW,Red Green,Blue,Amber	N/A	Constant current	350mA	Series	3M 2X0.75mm <sup>2</sup> Cable	3W	N/A	D88X45	D65
GL154	CREE	CW,WW, NW,Red Green,Blue,Amber	N/A	Constant current	350mA	Series	3M 2X0.75mm <sup>2</sup> Cable	3W	N/A	D88X45	D65
GL151D	CREE	CW,WW, NW,Red Green,Blue,Amber	N/A	Constant voltage	12/24VDC	Parallel	3M 2X0.75mm <sup>2</sup> Cable	3.5W	N/A	D88X45	D65
GL152D	CREE	CW,WW, NW,Red Green,Blue,Amber	N/A	Constant voltage	12/24VDC	Parallel	3M 2X0.75mm <sup>2</sup> Cable	3.5W	N/A	D88X45	D65
GL154D	CREE	CW,WW, NW,Red Green,Blue,Amber	N/A	Constant voltage	12/24VDC	Parallel	3M 2X0.75mm <sup>2</sup> Cable	3.5W	N/A	D88X45	D65

\*IES Data support.

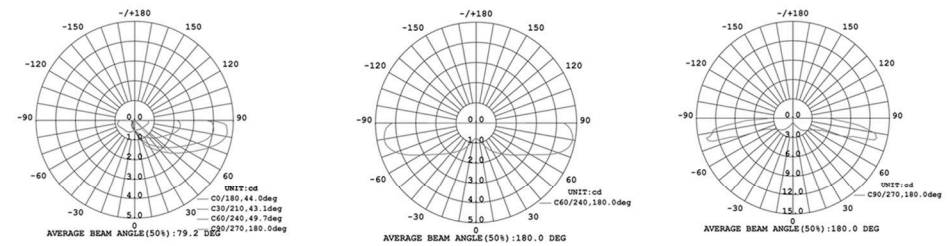

LED Colours

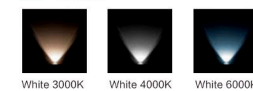

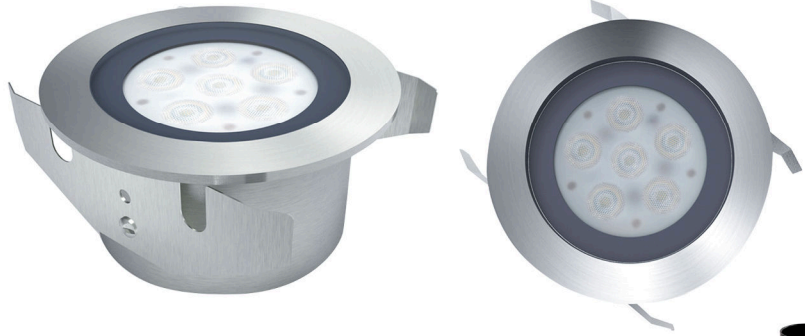

■ GL166

Midsize surface fixture complete with integral CREE XED(6pcsLED) package and 10/40 degree beam options. Tempered glass, marine Grade 316 Stainless Steel construction rated to IP68. Hidden & embedded design installation. No mechanical joints to light source ensures robust protection against water ingress. Product runs cool meeting all touch temperature requirements. Inline 350mA driver options include switched, mains, 1-10V and DALI dimmable solutions

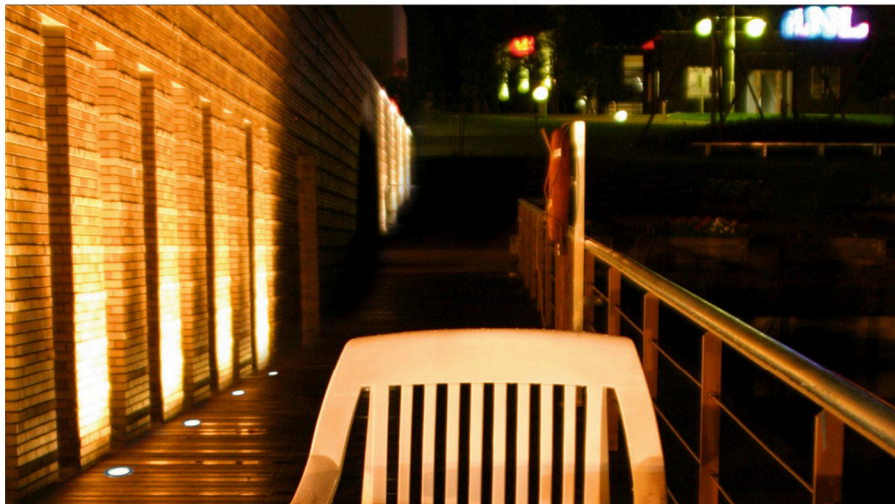

DESCRIPTION

<b>LED Light source</b>	High Power LED
<b>Light Color</b>	RGB,CW,WW,NW,Red,Green,Blue,Amber
<b>Material</b>	SUS316
<b>Optics</b>	S10° / F40°
<b>Power</b>	6W
<b>Power supply</b>	N/A
<b>Dimension</b>	D96X47
<b>Weight</b>	940g
<b>IP Rating</b>	IP68
<b>Approvals</b>	CE,RoHS,IP
<b>Ambient temperature</b>	-20°C ~ +45°C
<b>Average life</b>	50,000Hrs
<b>Accessories(Optional)</b>	Yes
<b>Applications</b>	Indoor/Outdoor/Landscape/Submersible

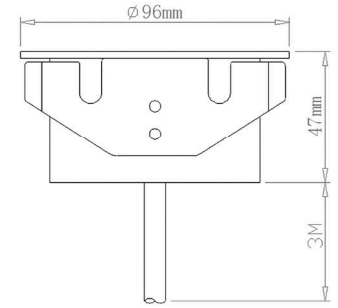

Model No.	LED Brand	Color	Beam	PowerMode	Input	Wiring	Cable	Power	Luminous Flux	Dimension	DrillSize
GL166	CREE	CW,WW, NW,Red Green,Blue,Amber	S10/F40	Constant current	350mA	Series	3M 2X0.75mm <sup>2</sup> Cable	6W	600LM	D96X47	D85
GL166D	CREE	CW,WW, NW,Red Green,Blue,Amber	S10/F40	Constant voltage	24VDC	Parallel	3M 2X0.75mm <sup>2</sup> Cable	6.5W	600LM	D96X47	D85
GL166RGB	CREE	2R+2G+2B	S10/F40	Constant current	350mA	Series	2x3M 4X0.5mm <sup>2</sup> Cable	6W	N/A	D96X47	D85
GL166DMX-RGB	CREE	2R+2G+2B	S10/F40	Constant voltage	24VDC DMX Controller	Parallel	1.1M 4X0.5mm <sup>2</sup> Cable	6.5W	N/A	D96X47	D85
GL166DMX-RGB	Edison	RGB(Fullcolor)	S10/F40	Constant voltage	24VDC DMX Controller	Parallel	1.1M 4X0.5mm <sup>2</sup> Cable	6.5W	N/A	D96X47	D85
GL166DMX RGBW	Edison	RGBW(Fullcolor)	S10/F40	Constant voltage	24VDC DMX Controller	Parallel	1.1M 4X0.5mm <sup>2</sup> Cable	6.5W	N/A	D96X47	D85

DMX decoder in built

\*IES Data support.

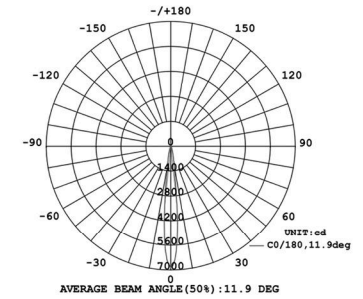
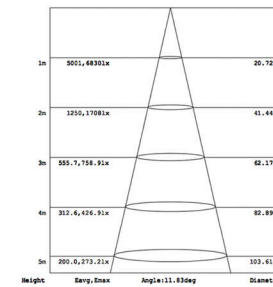

LED Colours

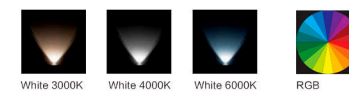



Optional accessories

GL168

Midsized surface fixture complete with integral CREE XPE LED(8pcsLED) package and 10/40 degree beam options. Tempered glass, marine grade 316 Stainless Steel construction rated to IP68. Hidden & embedded design installation. No mechanical joints to light source ensures robust protection against water ingress. Product runs cool meeting all touch temperature requirements. Inline 350mA driver options include switched, mains, 1-10V and DALI dimmable solutions.

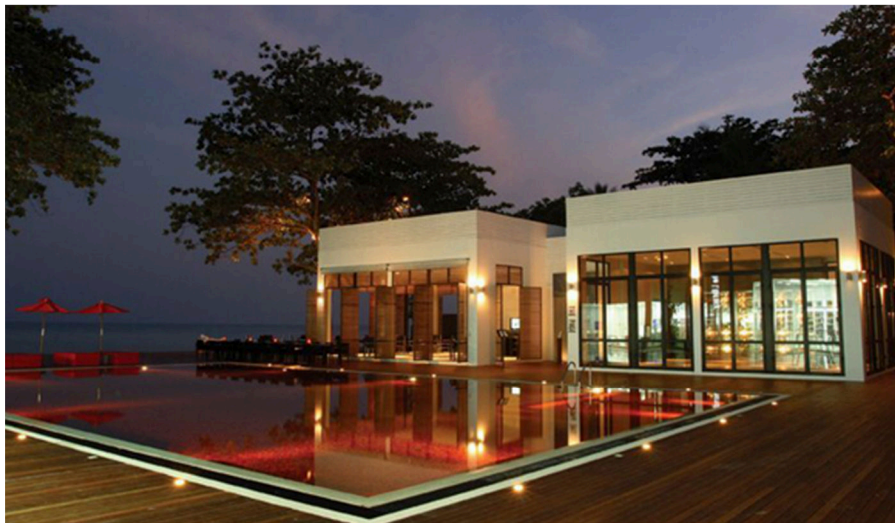

DESCRIPTION

<b>LED Light source</b>	High Power LED
<b>Light Color</b>	RGB,CW,WW,NW,Red,Green,Blue,Amber
<b>Material</b>	SUS316
<b>Optics</b>	S10° / F40°
<b>Power</b>	8W
<b>Power supply</b>	N/A
<b>Dimension</b>	D96X47
<b>Weight</b>	940g
<b>IP Rating</b>	IP68
<b>Approvals</b>	CE,RoHS,IP
<b>Ambient temperature</b>	-20°C ~ +45°C
<b>Average life</b>	50,000Hrs
<b>Accessories(Optional)</b>	Yes
<b>Applications</b>	Indoor/Outdoor/Landscape/Submersible

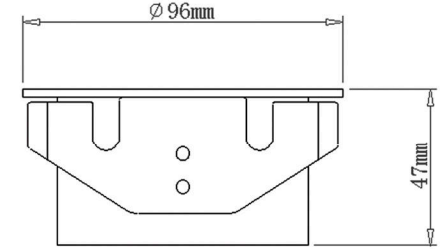

Model No.	LED Brand	Color	Beam	PowerMode	Input	Wiring	Cable	Power	Luminous Flux	Dimension	DrillSize
GL168	CREE	CW,WW, NW,Red,Green,Blue,Amber	S10/F40	Constant current	350mA	Series	3M 2X0.75mm <sup>2</sup> Cable	8W	800LM	D96X47	D85
GL168D	CREE	CW,WW, NW,Red,Green,Blue,Amber	S10/F40	Constant voltage	24VDC	Parallel	3M 2X0.75mm <sup>2</sup> Cable	9W	800LM	D96X47	D85
GL168RGB	CREE	3R+3G+2B	S10/F40	Constant current	350mA	Series	2x3M 4X0.5mm <sup>2</sup> Cable	8W	N/A	D96X47	D85
GL168DMX-RGB	CREE	3R+3G+2B	S10/F40	Constant voltage	24VDC DMX Controller	Parallel	1.1M 4X0.5mm <sup>2</sup> Cable	9W	N/A	D96X47	D85

DMX decoder in built

\*IES Data support.

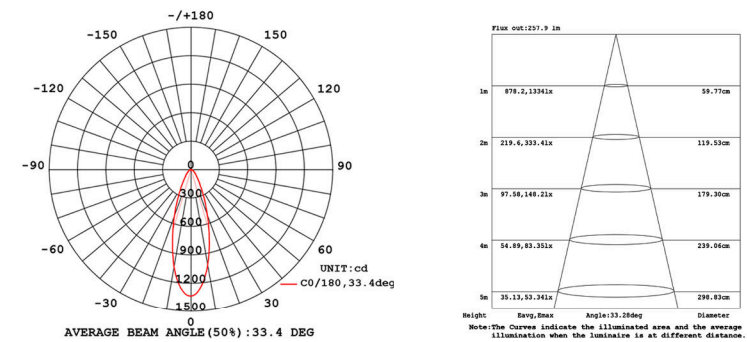

LED Colours

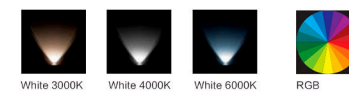



TS119  
Optional accessories

■ GL191

Marine grade 316 stainless steel in-ground light complete with integral CREE LED package. Tempered glass, fixture rated to IP68 allowing submersion in water thus negating common issues arising from lack of soil drainage. Product functions with 350mA constant current driver. No mechanical joints to light source ensures robust protection against water ingress. Product runs cool meeting all "touch temperature" requirements.

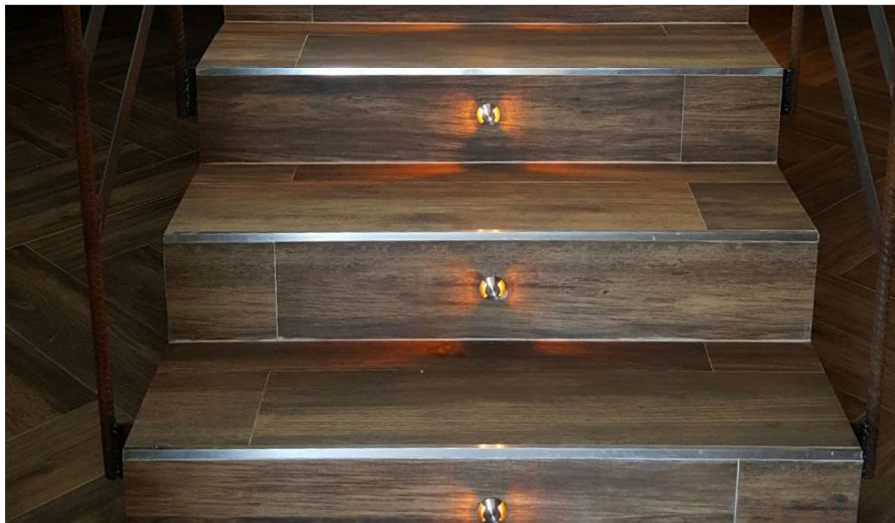

DESCRIPTION

LED Light source	High Power LED
Light Color	CW,WW,NW,Red,Green,Blue,Amber
Material	SUS316
Optics	N/A
Power	1W
Power supply	N/A
Weight	140g
IP Rating	IP68
Approvals	CE,RoHS,IP
Ambient temperature	-20°C ~ +45°C
Average life	50,000Hrs
Accessories(Optional)	Yes
Applications	Indoor/Outdoor/Landscape/Submersible

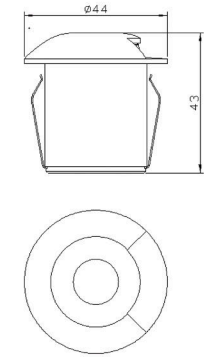

Model No.	LED Brand	Color	Beam	PowerMode	Input	Wiring	Cable	Power	Luminous Flux	Dimension	DrillSize
GL191	CREE	CW,WW, NW,Red Green,Blue,Amber	N/A	Constant current	350mA	Series	1.1M 2X0.4mm <sup>2</sup> Cable	1W	N/A	D44X43	D32
GL192	CREE	CW,WW, NW,Red Green,Blue,Amber	N/A	Constant current	350mA	Series	1.1M 2X0.4mm <sup>2</sup> Cable	1W	N/A	D44X43	D32
GL193	CREE	CW,WW, NW,Red Green,Blue,Amber	N/A	Constant current	350mA	Series	1.1M 2X0.4mm <sup>2</sup> Cable	1W	N/A	D44X43	D32
GL191D	CREE	CW,WW, NW,Red Green,Blue,Amber	N/A	Constant voltage	24VDC	Parallel	1.1M 2X0.4mm <sup>2</sup> Cable	1.3W	N/A	D44X43	D32
GL192D	CREE	CW,WW, NW,Red Green,Blue,Amber	N/A	Constant voltage	24VDC	Parallel	1.1M 2X0.4mm <sup>2</sup> Cable	1.3W	N/A	D44X43	D32
GL193D	CREE	CW,WW, NW,Red Green,Blue,Amber	N/A	Constant voltage	24VDC	Parallel	1.1M 2X0.4mm <sup>2</sup> Cable	1.3W	N/A	D44X43	D32

\*IES Data support.

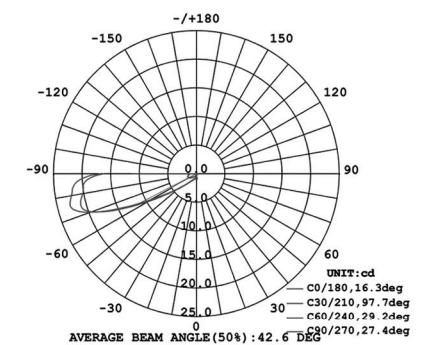
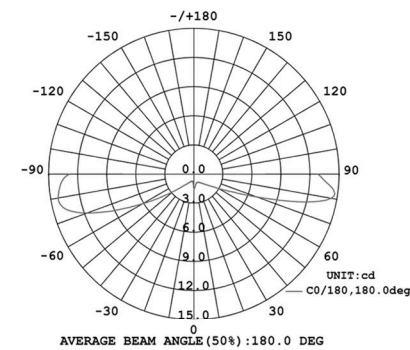

LED Colours





**DESCRIPTION**

<b>LED Light source</b>	High Power LED
<b>Light Color</b>	RGB,CW,WW,NW,Red,Green,Blue,Amber
<b>Material</b>	SUS316(Lamp cap)+Aluminium(Lamp cup)
<b>Optics</b>	10/40
<b>Power</b>	12W
<b>Power supply</b>	350mA or 24VDC
<b>Weight</b>	N/A
<b>IP Rating</b>	IP68
<b>Approvals</b>	CE,RoHS,IP
<b>Ambient temperature</b>	-20°C ~ +45°C
<b>Accessories(Optional)</b>	N/A
<b>Applications</b>	Indoor/Outdoor

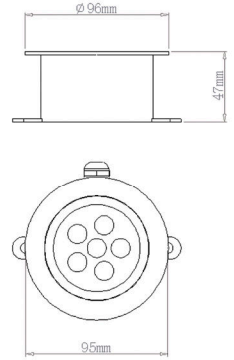

■ **GL266**

Midsized surface fixture complete with integral CREE XPE LED (6pcs LED) package and 10/40 degree beam options. Tempered glass, marine grade 316 Stainless Steel construction rated to IP68. No mechanical joints to light source ensures robust protection against water ingress. Product runs cool meeting all touch temperature requirements. Inline 350mA driver options include switched, mains, 1-10V and DALI dimmable solutions.

Model No.	LED Brand	Color	Beam	PowerMode	Input	Wiring	Cable	Power	Luminous Flux	Dimension	DrillSize
GL266	CREE	CW,WW, NW,Red Green,Blue,Amber	S10/F40	Constant current	350mA	Series	3M 2X0.75mm <sup>2</sup> Cable	6W	600LM	D96X47	N/A
GL266D	CREE	CW,WW, NW,Red Green,Blue,Amber	S10/F40	Constant voltage	24VDC	Parallel	3M 2X0.75mm <sup>2</sup> Cable	6.5W	600LM	D96X47	N/A
GL266RGB	CREE	RGB(2R+2G+2B)	S10/F40	Constant current	350mA	Series	2x3M 4X0.5mm <sup>2</sup> Cable	6W	N/A	D96X47	N/A

\*IES Data support.

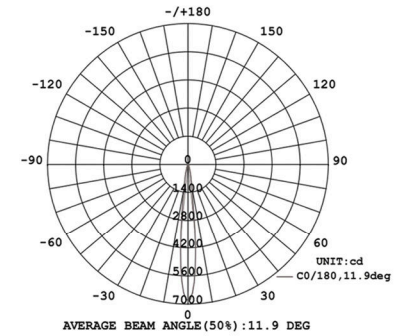
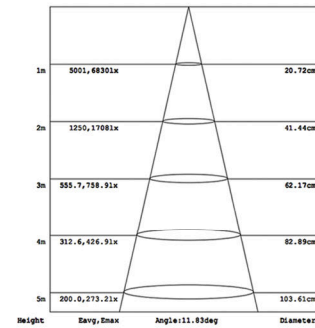
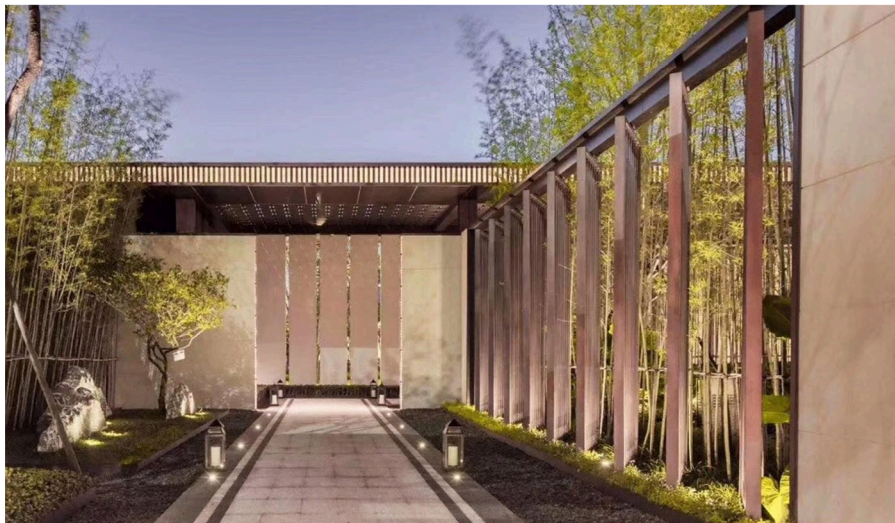

**LED Colours**

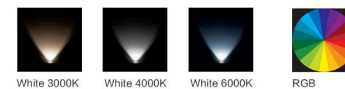





DESCRIPTION

<b>LED Light source</b>	High Power LED
<b>Light Color</b>	RGB,CW,WW,NW,Red,Green,Blue,Amber
<b>Material</b>	SUS316
<b>Optics</b>	S10° / F40°
<b>Power</b>	8W
<b>Power supply</b>	N/A
<b>Dimension</b>	D96X47
<b>Weight</b>	940g
<b>IP Rating</b>	IP68
<b>Approvals</b>	CE,RoHS,IP
<b>Ambient temperature</b>	-20°C ~ +45°C
<b>Average life</b>	50,000Hrs
<b>Accessories(Optional)</b>	N/A
<b>Applications</b>	Indoor/Outdoor/Landscape/Submersible

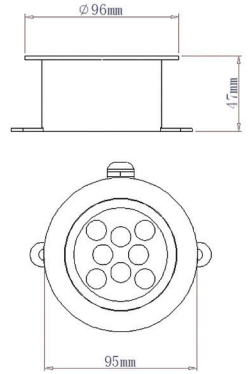

■ GL268

Midsized surface fixture complete with integral CREE XPE LED(8pcsLED) package and 10/40 degree beam options. Tempered glass marine grade 316 Stainless Steel construction rated to IP68. No mechanical joints to light source ensures robust protection against water ingress. Product runs cool meeting all touch temperature requirements. In-line 350mA driver options include switched, mains 1-10V and DALI dimmable solutions.

Model No.	LED Brand	Color	Beam	PowerMode	Input	Wiring	Cable	Power	Luminous Flux	Dimension	DrillSize
GL268	CREE	CW,WW, NW,Red Green,Blue,Amber	S10/F40	Constant current	350mA	Series	3M 2X0.75mm <sup>2</sup> Cable	8W	800LM	D96X47	N/A
GL268D	CREE	CW,WW, NW,Red Green,Blue,Amber	S10/F40	Constant voltage	24VDC	Parallel	3M 2X0.75mm <sup>2</sup> Cable	9W	800LM	D96X47	N/A
GL268RGB	CREE	RGB(3R+3G+2B)	S10/F40	Constant current	350mA	Series	2x3M 4X0.5mm <sup>2</sup> Cable	8W	N/A	D96X47	N/A



\*IES Data support.

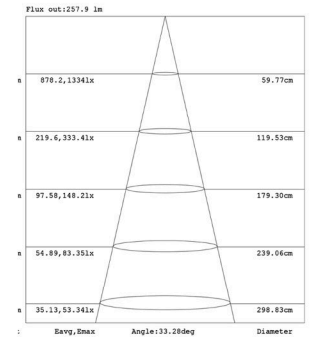
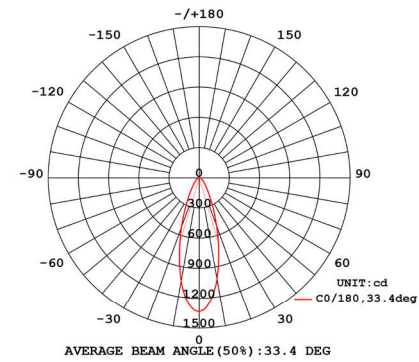

LED Colours





# FOUNTAIN LIGHT

SPECIALIZED MANUFACTURER LED LIGHTING PRODUCTS



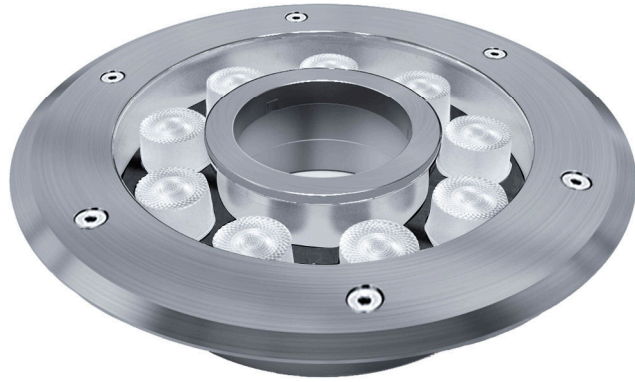

**DESCRIPTION**

**LED Light source** High Power LED  
**Light Color** RGB,CW,WW,NW,Red,Green,Blue,Amber  
**Material** SUS316 + 6mm Toughened glass  
**Optics** 15° / S20° / 30° / 45° / F60°  
**Power** 9W / 9+2W / 9+3W  
**Power supply** 12VDC or 24VDC  
**Dimension** D173XH41  
**Weight** 1420g  
**IP Rating** IP68  
**Approvals** CE,RoHS,IP  
**Ambient temperature** -20°C ~ +45°C  
**Average life** 50,000Hrs  
**Accessories(Optional)** Constant voltage DMX Controller  
**Applications** surface mounted;  
 Fountains, artificial lakes,  
 natural lakes, swimming halls,  
 aquariums and other underwater  
 lighting or decoration may apply

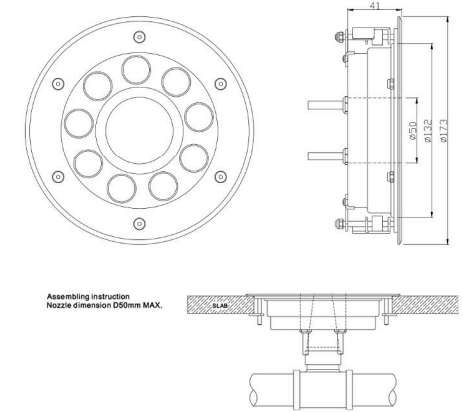

Model No.	LED Brand	Color	Beam	Input	Wiring	Cable	Power	Luminous Flux	Dimension	Aperture	DrillSize
FL410D	CREE	CW,WW, NW,Red Green,Blue,Amber	15/S20/30/45/F60	12VDC or 24VDC	Parallel	3M 2X0.75mm <sup>2</sup> Cable or 1.1M Plug	9W	800LM	D173XH41	D50	D160
FL410DMX	CREE	CW,WW, NW,Red Green,Blue,Amber	15/S20/30/45/F60	12VDC or 24VDC DMX Controller	Parallel	2x1.1M 5X0.5mm <sup>2</sup> Cable or 1.1M Plug	10W	800LM	D173XH41	D50	D160
FL410DMX-RGB	CREE	3R+3G+3B	15/S20/30/45/F60	12VDC or 24VDC DMX Controller	Parallel	2x1.1M 5X0.5mm <sup>2</sup> Cable or 1.1M Plug	10W	N/A	D173XH41	D50	D160
FL410DMX-RGB	Edison	RGB(Fullcolor)	15/S20/30/45/F60	12VDC or 24VDC DMX Controller	Parallel	2x1.1M 5X0.5mm <sup>2</sup> Cable or 1.1M Plug	10W	N/A	D173XH41	D50	D160
FL410DMX-RGBW	Edison	RGBW(Fullcolor)	15/S20/30/45/F60	12VDC or 24VDC DMX Controller	Parallel	2x1.1M 5X0.5mm <sup>2</sup> Cable or 1.1M Plug	12W	N/A	D173XH41	D50	D160

DMX decoder is built

\*IES Data support.  
 \*Power could be customized

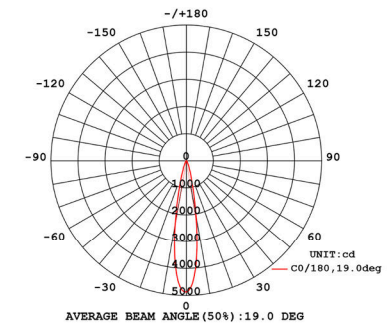
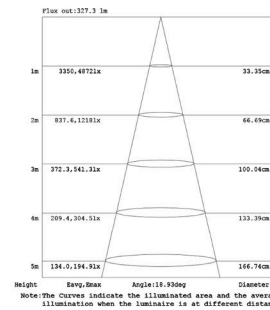
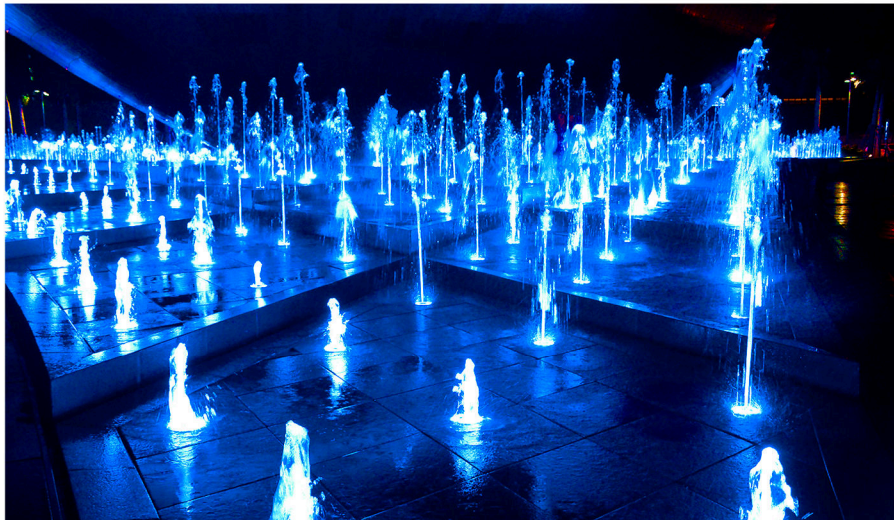

**LED Colours**

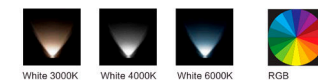



DESCRIPTION

**LED Light source** High Power LED  
**Light Color** RGB,CW,WW,NW,Red,Green,Blue,Amber  
**Material** SUS316  
**Optics** 15° / S20° / 30° / 45° / F60°  
**Power** 9W / 9+2W / 9+3W  
**Power supply** 12VDC or 24VDC  
**Dimension** D155XH55  
**Weight** 1460g  
**IP Rating** IP68  
**Approvals** CE,RoHS,IP  
**Ambient temperature** -20°C ~ +45°C  
**Average life** 50,000Hrs  
**Accessories(Optional)** Constant voltage DMX Controller  
**Applications** Fountains, artificial lakes, natural lakes, swimming halls, aquariums and other underwater lighting or decoration may apply

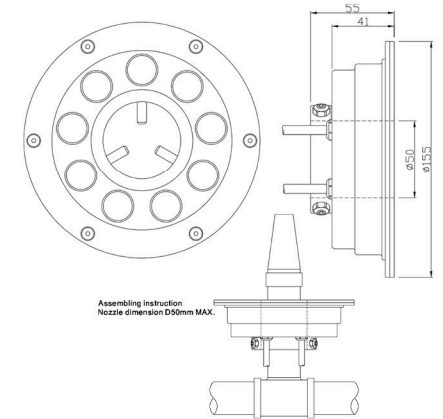

Model No.	LED Brand	Color	Beam	Input	Wiring	Cable	Power	Luminous Flux	Dimension	Aperture	Drill Size
FL411D	CREE	CW,WW, NW,Red Green,Blue,Amber	15/S20/30/45/F60	12VDC or 24VDC	Parallel	3M 2X0.75mm <sup>2</sup> Cable or 1.1M Plug	9W	800LM	D155XH55	D50	N/A
FL411DMX	CREE	CW,WW, NW,Red Green,Blue,Amber	15/S20/30/45/F60	12VDC or 24VDC DMX Controller	Parallel	2x1.1M 5X0.5mm <sup>2</sup> Cable or 1.1M Plug	10W	800LM	D155XH55	D50	N/A
FL411DMX-RGB	CREE	3R+3G+3B	15/S20/30/45/F60	12VDC or 24VDC DMX Controller	Parallel	2x1.1M 5X0.5mm <sup>2</sup> Cable or 1.1M Plug	10W	N/A	D155XH55	D50	N/A
FL411DMX-RGB	Edison	RGB(Fullcolor)	15/S20/30/45/F60	12VDC or 24VDC DMX Controller	Parallel	2x1.1M 5X0.5mm <sup>2</sup> Cable or 1.1M Plug	10W	N/A	D155XH55	D50	N/A
FL411DMX-RGBW	Edison	RGBW(Fullcolor)	15/S20/30/45/F60	12VDC or 24VDC DMX Controller	Parallel	2x1.1M 5X0.5mm <sup>2</sup> Cable or 1.1M Plug	12W	N/A	D155XH55	D50	N/A



DMX decoder in built

\*IES Data support.  
 \*Power could be customized

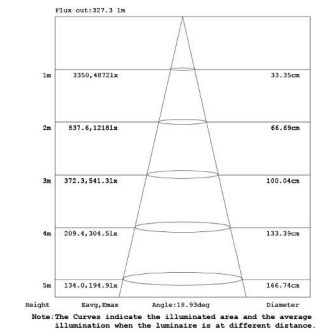
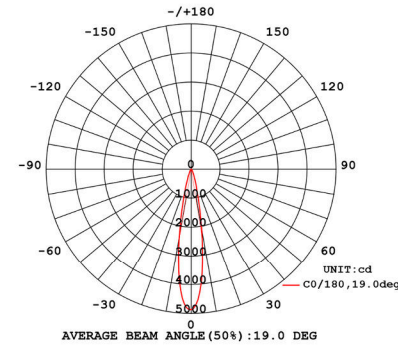

LED Colours

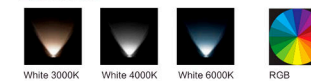



# SPOT LIGHT

SPECIALIZED MANUFACTURER  
LED LIGHTING PRODUCTS

DESCRIPTION

**LED Light source** High Power LED  
**Light Color** CW,WW,NW,Red,Green,Blue,Amber  
**Material** Aluminum  
**Optics** 12° / 45°  
**Power** 1W  
**Power supply** N/A  
**Dimention** N/A  
**Weight** N/A  
**IP Rating** IP65  
**Approvals** CE,RoHS  
**Ambient temperature** -20°C ~ +45°C  
**Average life** 50,000Hrs  
**Accessories(Optional)** YES  
**Applications** Indoor / Outdoor / Landscape  
**Optional brand** CREE

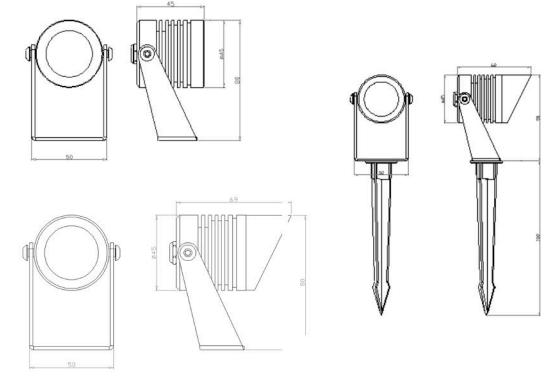

■ EU3036

In a typical spotlight design. Finished to a high standard using anodized aluminum makes it suitable for both indoor and outdoor applications, construction rated to IP65 and configured to 12/45 degree beam options. Using an adjustable head and cowl design for low glare, means directing the light could not be easier. Maximum visual comfort for superior standards

Model No.	LED Brand	Color	Beam	PowerMode	Input	Wiring	Cable	Power	Luminous Flux	Dimention	DrillSize
EU3036	CREE	CW,WW,NW,Red,Green,Blue,Amber	S12/F45	Constant current	350mA	Series	3M 2X0.75mm <sup>2</sup> Cable	1W	90LM	L45XW50XH80	
EU3036D	CREE	CW,WW,NW,Red,Green,Blue,Amber	S12/F45	Constant voltage	24VDC	Parallel	3M 2X0.75mm <sup>2</sup> Cable	1.3W	90LM	L45XW50XH80	
EU3036DMX	CREE	CW,WW,NW,Red,Green,Blue,Amber	S12/F45	Constant voltage	24VDC DMX Controller	Parallel	3M 4X0.5mm <sup>2</sup> Cable	1.3W	90LM	L45XW50XH80	
EU3036X	CREE	CW,WW,NW,Red,Green,Blue,Amber	S12/F45	Constant current	350mA	Series	3M 2X0.75mm <sup>2</sup> Cable	1W	90LM	L69XW50XH80	
EU3036XD	CREE	CW,WW,NW,Red,Green,Blue,Amber	S12/F45	Constant voltage	24VDC	Parallel	3M 2X0.75mm <sup>2</sup> Cable	1.3W	90LM	L69XW50XH80	
EU3036X-DMX	CREE	CW,WW,NW,Red,Green,Blue,Amber	S12/F45	Constant voltage	24VDC DMX Controller	Parallel	3M 4X0.5mm <sup>2</sup> Cable	1.3W	90LM	L69XW50XH80	
EU3036X-SP	CREE	CW,WW,NW,Red,Green,Blue,Amber	S12/F45	Constant current	350mA	Series	3M 2X0.75mm <sup>2</sup> Cable	1W	90LM	L69XW50XH230	
EU3036X-SPD	CREE	CW,WW,NW,Red,Green,Blue,Amber	S12/F45	Constant voltage	24VDC	Parallel	3M 2X0.75mm <sup>2</sup> Cable	1.3W	90LM	L69XW50XH230	
EU3036X-SPDMX	CREE	CW,WW,NW,Red,Green,Blue,Amber	S12/F45	Constant voltage	24VDC DMX Controller	Parallel	3M 4X0.5mm <sup>2</sup> Cable	1.3W	90LM	L69XW50XH230	

DMX decoder in built

\*IES Data support.

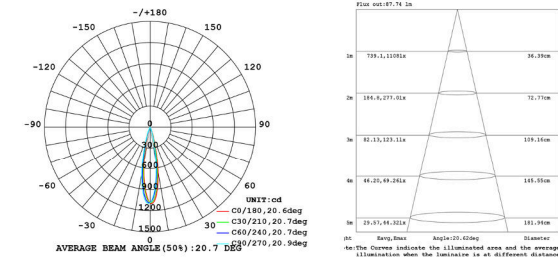

LED Colours

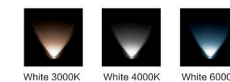



DESCRIPTION

**LED Light source** High Power LED  
**Light Color** CW,WW,NW  
**Material** Aluminum  
**Optics** 3°  
**Power** 7W  
**Power supply** N/A  
**Dimension** D62XH93XT82  
**Weight** N/A  
**IP Rating** IP67  
**Approvals** CE,RoHS  
**Ambient temperature** -20°C ~ +45°C  
**Average life** 50,000Hrs  
**Accessories(Optional)** N/A  
**Applications** Indoor/Outdoor/Landscape  
**Optional brand** CREE

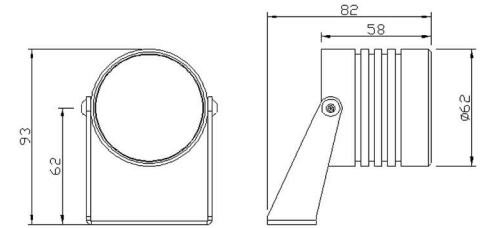

■ EU3040

Finished to a high standard using anodized aluminum makes it suitable for both indoor and outdoor applications, construction rated to IP67 and configured to 3 degree beam angle. No mechanical joints to light source ensures robust protection against water ingress. Product runs cool meeting all touch temperature requirements

Model No.	LED Brand	Color	Beam	PowerMode	Input	Wiring	Cable	Power	Luminous Flux	Dimension
EU3040	CREE	CW,WW,NW	3°	Constant current	600mA@11.3VDC	Series	3M 2X0.75mm <sup>2</sup> Cable	7W	600LM	D62XH93XT82
EU3040D	CREE	CW,WW,NW	3°	Constant voltage	24VDC	Parallel	3M 2X0.75mm <sup>2</sup> Cable	7.5W	600LM	D62XH93XT82
EU3040DMX	CREE	CW,WW,NW	3°	Constant voltage	24VDC	Parallel	3M 4X0.5mm <sup>2</sup> Cable	7.5W	600LM	D62XH93XT82



\*IES Data support.

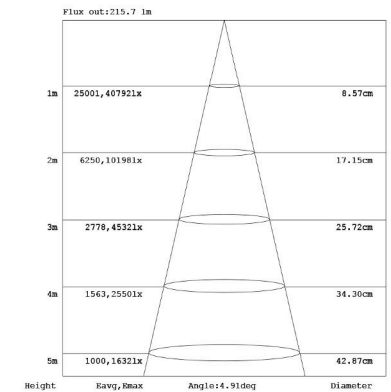
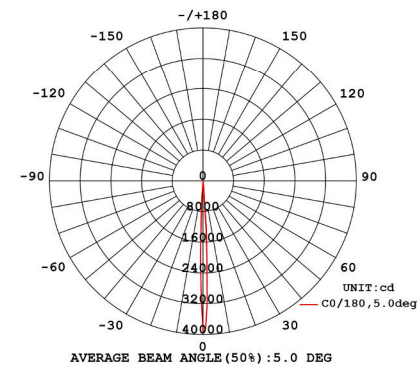

LED Colours

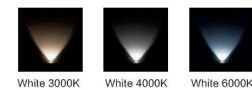



■ EU3042

Bar stock stainless steel surface mounted projector complete with integral CREE LED package. Fixture rated to IP68. No mechanical joints to light source ensures robust protection against water ingress. Suitable for the illumination of small/medium trees, building exteriors, columns if the voltage less than 18W. Above 18W, the luminaires may only be operated under water, recessed luminaires for private and public swimming pools. Underwater luminaires in various sizes and light outputs for installation in concrete, foil, metal or synthetic pools. To avoid harmful deposits and dirt on the luminaires, the water must have a neutral pH value and must be free of components that attack metal.

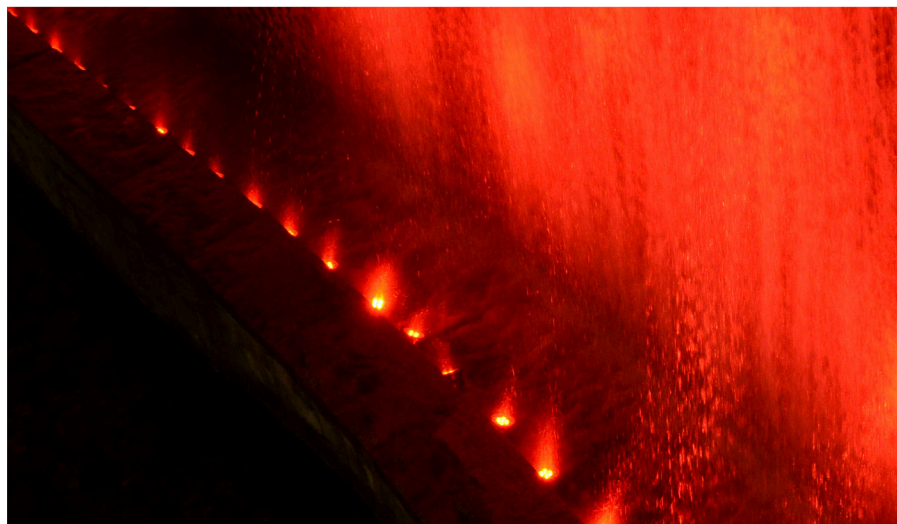

DESCRIPTION

<b>LED Light source</b>	High Power LED
<b>Light Color</b>	CW,WW,NW,Red,Green,Blue,Amber
<b>Material</b>	SUS316(Lamp cap)+SUS316(Lamp cup)
<b>Optics</b>	20° / 60° (10° / 30° / 45°)
<b>Power</b>	12W
<b>Power supply</b>	N/A
<b>Dimension</b>	D153XH173XT48(T55)
<b>Weight</b>	1kg
<b>IP Rating</b>	IP68
<b>Approvals</b>	CE,RoHS
<b>Ambient temperature</b>	-20°C ~ +45°C
<b>Average life</b>	50,000Hrs
<b>Accessories(Optional)</b>	N/A
<b>Applications</b>	Indoor/Outdoor/Landscape/Submersible
<b>Optional brand</b>	CREE

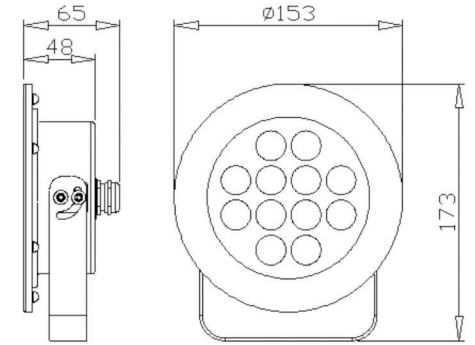

Model No.	LED Brand	Color	Beam	PowerMode	Input	Wiring	Cable	Power	Luminous Flux	Dimension
EU3042	CREE	CW,WW,NW Red Green,Blue,Amber	S20/F60 (10/30/45)	Constant current	350mA	Series	3M 2X0.75mm <sup>2</sup> Cable	12W	1000LM	D153XH173XT48
EU3042D	CREE	CW,WW,NW Red Green,Blue,Amber	S20/F60 (10/30/45)	Constant voltage	24VDC	Parallel	3M 2X0.75mm <sup>2</sup> Cable	13W	1000LM	D153XH173XT48
EU3042DM	OSRAM	CW,WW,NW Red Green,Blue,Amber	120	Constant voltage	24VDC	Parallel	3M 2X0.75mm <sup>2</sup> Cable	13W	500LM	D153XH173XT48
EU3042DMX	CREE	CW,WW,NW Red Green,Blue,Amber	S20/F60 (10/30/45)	Constant voltage	24VDC DMX Controller	Parallel	3M 4X0.5mm <sup>2</sup> Cable	13W	1000LM	D153XH173XT48
* EU3042D-24W	CREE	CW,WW,NW Red Green,Blue,Amber	S20/F60 (10/30/45)	Constant voltage	24VDC	Parallel	3M 2X0.75mm <sup>2</sup> Cable	24W	2000LM	D153XH173XT48
* EU3042D-36W	CREE	CW,WW,NW	S20/F60 (10/30/45)	Constant voltage	24VDC	Parallel	3M 2X0.75mm <sup>2</sup> Cable	36W	2800LM	D153XH173XT48
EU3042DMX-RGB	Edison	RGB,RGBW	S20/F60 (10/30/45)	Constant voltage	24VDC DMX Controller	Parallel	3M 4X0.5mm <sup>2</sup> Cable	13W	N/A	D153XH173XT48
* EU3042DMX-24W-RGB	Edison	RGB,RGBW	S20/F60 (10/30/45)	Constant voltage	24VDC DMX Controller	Parallel	3M 4X0.5mm <sup>2</sup> Cable	24W	N/A	D153XH173XT48
* EU3042DMX-36W-RGBW	Edison	RGBW	S20/F60 (10/30/45)	Constant voltage	24VDC DMX Controller	Parallel	3M 4X0.5mm <sup>2</sup> Cable	36W	N/A	D153XH173XT48

\*Underwater use only

\*IES Data support.

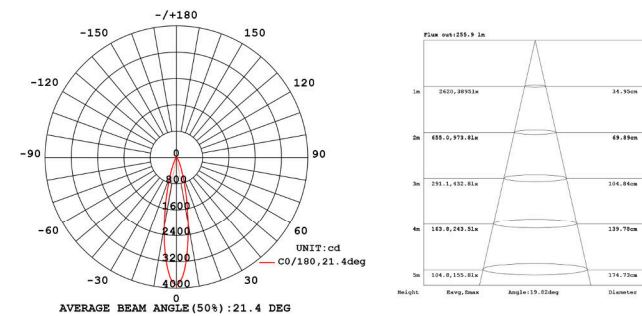

LED Colours

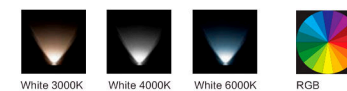





■ PL608

Bar stock aluminum surface mounted projector complete with Integral CREE LED(6pcs)package.Tempered glass,fixture rated to IP67 and configured to 10/40 degree beam options.NO mechanical joints to light source ensures robust protection against water ingress.Product runs cool meeting all touch temperature requirements.suitable for the illumination of small/medium trees,building exteriors,columns.

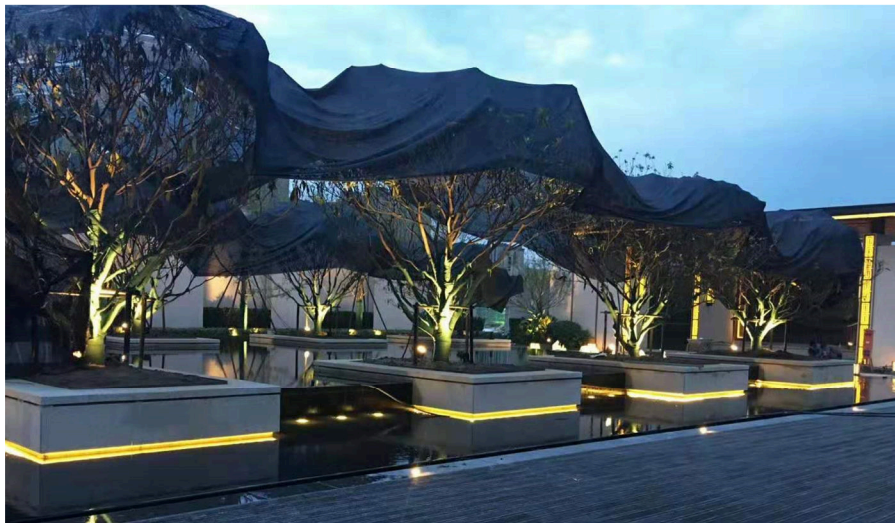

DESCRIPTION

<b>LED Light source</b>	High Power LED
<b>Light Color</b>	RGB,CW,WW,NW,Red,Green,Blue,Amber
<b>Material</b>	Aluminium
<b>Optics</b>	S10° / F40°
<b>Power</b>	6x1W (3x1W)
<b>Power supply</b>	N/A
<b>Dimention</b>	93X70X112
<b>Weight</b>	300g
<b>IP Rating</b>	IP67
<b>Approvals</b>	CE,RoHS,IP
<b>Ambient temperature</b>	-20°C ~ +45°C
<b>Average life</b>	50,000Hrs
<b>Accessories(Optional)</b>	N/A
<b>Applications</b>	Indoor/Outdoor/Landscape

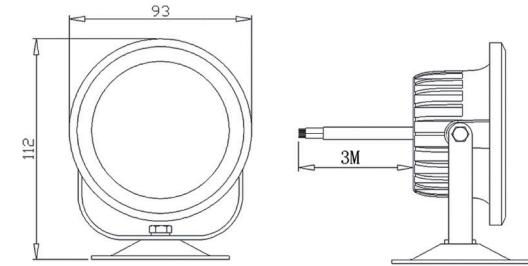

Model No.	LED Brand	Color	Beam	PowerMode	Input	Wiring	Cable	Power	Luminous Flux	Dimention	DrillSize
PL608	CREE	CW,WW, NW,Red Green,Blue,Amber	S10/F40	Constant current	350mA	Series	3M 2X0.75mm <sup>2</sup> Cable	6W	500LM	93X70X112	N/A
PL608D	CREE	CW,WW, NW,Red Green,Blue,Amber	S10/F40	Constant voltage	24VDC	Parallel	3M 2X0.75mm <sup>2</sup> Cable	6.5W	500LM	93X70X112	N/A
PL608RGB	CREE	2R+2G+2B	S10/F40	Constant current	350mA	Series	2x3M 4X0.5mm <sup>2</sup> Cable	6W	N/A	93X70X112	N/A
PL608DMX-RGB	CREE	2R+2G+2B	S10/F40	Constant voltage	24VDC DMX Controller	Parallel	1.1M 4X0.5mm <sup>2</sup> Cable	6.5W	N/A	93X70X112	N/A
PL608DMX-RGB	Edison	RGB(Fullcolor)	S10/F40	Constant voltage	24VDC DMX Controller	Parallel	1.1M 4X0.5mm <sup>2</sup> Cable	6.5W	N/A	93X70X112	N/A
PL608DMX-RGBW	Edison	RGBW(Fullcolor)	S10/F40	Constant voltage	24VDC DMX Controller	Parallel	1.1M 4X0.5mm <sup>2</sup> Cable	6.5W	N/A	93X70X112	N/A

DMX decoder in built

\*IES Data support.

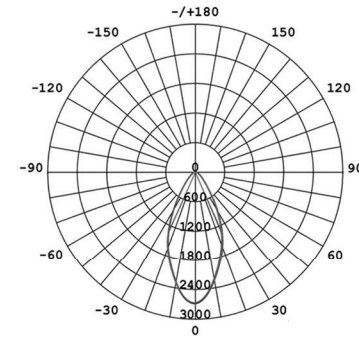

Height	Beam, Dmax	Angle: 48.04deg	Diameter
1m	1563,2683x		89.13cm
2m	390.9,671.31x		178.25cm
3m	173.7,288.31x		267.38cm
4m	97.71,167.81x		356.51cm
5m	62.54,107.41x		445.63cm

LED Colours

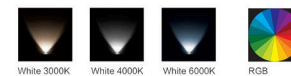



■ PL612

Bar stock aluminum surface mounted projector complete with Integral CREE LED(12pcs)package.Tempered glass,fixture rated to IP67 and configured to 10/20/40/60 degree beam options.NO mechanical joints to light source ensures robust protection against water ingress.Product runs cool meeting all touch temperature requirements.suitable for the illumination of small/medium trees,building exteriors,columns.



DESCRIPTION

<b>LED Light source</b>	High Power LED
<b>Light Color</b>	RGB,CW,WW,NW,Red,Green,Blue,Amber
<b>Material</b>	Aluminum+SUS316(Bracket)
<b>Optics</b>	10° / S20° / 40° / F60°
<b>Power</b>	12x1W
<b>Power supply</b>	N/A
<b>Dimention</b>	148XH170XT45
<b>Weight</b>	1.1KG
<b>IP Rating</b>	IP67
<b>Approvals</b>	CE,RoHS,IP
<b>Ambient temperature</b>	-20°C ~ +45°C
<b>Average life</b>	50,000Hrs
<b>Accessories(Optional)</b>	N/A
<b>Applications</b>	Indoor/Outdoor/Landscape

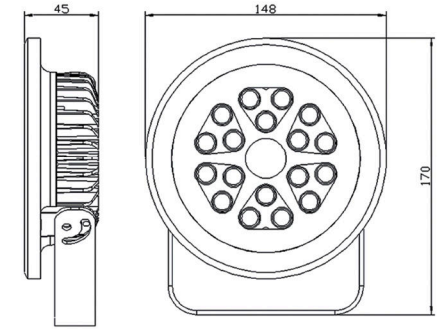

Model No.	LED Brand	Color	Beam	PowerMode	Input	Wiring	Cable	Power	Luminous Flux	Dimention	DrillSize
PL612	CREE	CW,WW, NW,Red Green,Blue,Amber	10/S20/40/F60	Constant current	350mA	Series	3M 2X0.75mm <sup>2</sup> Cable	12W	1300LM	148XH170XT45	N/A
PL612D	CREE	CW,WW, NW,Red Green,Blue,Amber	10/S20/40/F60	Constant voltage	24VDC	Parallel	3M 2X0.75mm <sup>2</sup> Cable	13W	1300LM	148XH170XT45	N/A
PL612RGB	CREE	4R+4G+4B	10/S20/40/F60	Constant current	350mA	Series	2x3M 4X0.5mm <sup>2</sup> Cable	12W	N/A	148XH170XT45	N/A
PL612DMX-RGB	CREE	4R+4G+4B	10/S20/40/F60	Constant voltage	24VDC DMX Controller	Parallel	1.1M 4X0.5mm <sup>2</sup> Cable	13W	N/A	148XH170XT45	N/A
PL612DMX-RGB	Edison	RGB(Fullcolor)	10/S20/40/F60	Constant voltage	24VDC DMX Controller	Parallel	1.1M 4X0.5mm <sup>2</sup> Cable	13W	N/A	148XH170XT45	N/A
PL612DMX-RGBW	Edison	RGBW(Fullcolor)	10/S20/40/F60	Constant voltage	24VDC DMX Controller	Parallel	1.1M 4X0.5mm <sup>2</sup> Cable	13W	N/A	148XH170XT45	N/A

DMX decoder in built

\*IES Data support.

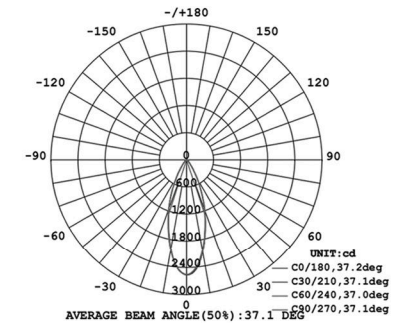
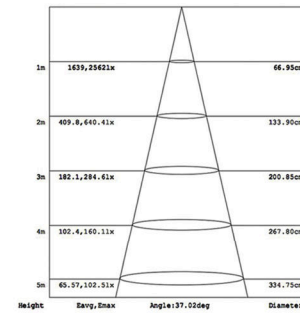

LED Colours

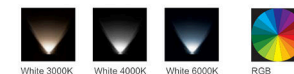



■ PL618

Bar stock aluminum surface mounted projector complete with Integral CREE LED(18pcs)package.Tempered glass ,fixture rated to IP67 and configured to 10/20/40/60 degree beam options.NO mechanical joints to light source ensures robust protection against water ingress.Product runs cool meeting all touch temperature requirements.suitable for the illumination of small/medium trees,building exteriors , columns.



DESCRIPTION

<b>LED Light source</b>	High Power LED
<b>Light Color</b>	RGB,CW,WW,NW,Red,Green,Blue,Amber
<b>Material</b>	Aluminum+SUS316(Bracket)
<b>Optics</b>	10° / S20° / 40° / F60°
<b>Power</b>	18x1W
<b>Power supply</b>	N/A
<b>Dimention</b>	148XH170XT45
<b>Weight</b>	1.1KG
<b>IP Rating</b>	IP67
<b>Approvals</b>	CE,RoHS,IP
<b>Ambient temperature</b>	-20°C ~ +45°C
<b>Average life</b>	50,000Hrs
<b>Accessories(Optional)</b>	N/A
<b>Applications</b>	Indoor/Outdoor/Landscape

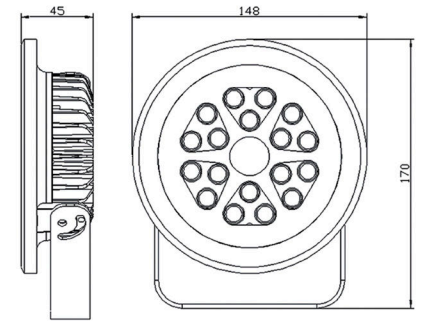

Model No.	LED Brand	Color	Beam	PowerMode	Input	Wiring	Cable	Power	Luminous Flux	Dimention	DrillSize
PL618	CREE	CW,WW, NW,Red,Green,Blue,Amber	10/S20/40/F60	Constant current	350mA	Series	3M 2X0.75mm <sup>2</sup> Cable	18W	1700LM	148XH170XT45	N/A
PL618D	CREE	CW,WW, NW,Red,Green,Blue,Amber	10/S20/40/F60	Constant voltage	24VDC	Parallel	3M 2X0.75mm <sup>2</sup> Cable	20W	1700LM	148XH170XT45	N/A
PL618RGB	CREE	6R+6G+6B	10/S20/40/F60	Constant current	350mA	Series	2x3M 4X0.5mm <sup>2</sup> Cable	18W	N/A	148XH170XT45	N/A
PL618DMX-RGB	CREE	6R+6G+6B	10/S20/40/F60	Constant voltage	24VDC DMX Controller	Parallel	1.1M 4X0.5mm <sup>2</sup> Cable	20W	N/A	148XH170XT45	N/A
PL618DMX-RGB	Edison	RGB(Fullcolor)	10/S20/40/F60	Constant voltage	24VDC DMX Controller	Parallel	1.1M 4X0.5mm <sup>2</sup> Cable	20W	N/A	148XH170XT45	N/A
PL618DMX-RGBW	Edison	RGBW(Fullcolor)	10/S20/40/F60	Constant voltage	24VDC DMX Controller	Parallel	1.1M 4X0.5mm <sup>2</sup> Cable	20W	N/A	148XH170XT45	N/A

DMX decoder is built

\*IES Data support.

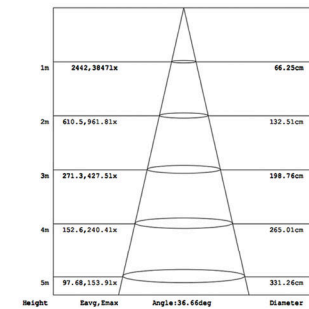
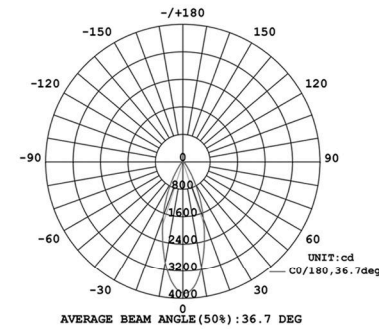

LED Colours

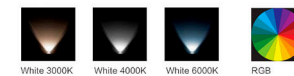



■ PL624

Bar stock aluminum surface mounted projector complete with integral CREE LED(24pcs) package. Tempered glass, fixture rated to IP67 and configured to 10/20/40/60 degree beam options. No mechanical joints to light source ensures robust protection against water ingress. Product runs cool meeting all touch temperature requirements. Suitable for the illumination of small/medium trees, building exteriors, columns.



DESCRIPTION

<b>LED Light source</b>	High Power LED
<b>Light Color</b>	RGB,CW,WW,NW,Red,Green,Blue,Amber
<b>Material</b>	Aluminium+SUS316(Bracket)
<b>Optics</b>	10° / S20° / 40° / F60°
<b>Power</b>	24x1W
<b>Power supply</b>	N/A
<b>Dimention</b>	214XH236XT50
<b>Weight</b>	1.7KG
<b>IP Rating</b>	IP67
<b>Approvals</b>	CE,RoHS,IP
<b>Ambient temperature</b>	-20°C ~ +45°C
<b>Average life</b>	50,000Hrs
<b>Accessories(Optional)</b>	N/A
<b>Applications</b>	Indoor/Outdoor/Landscape

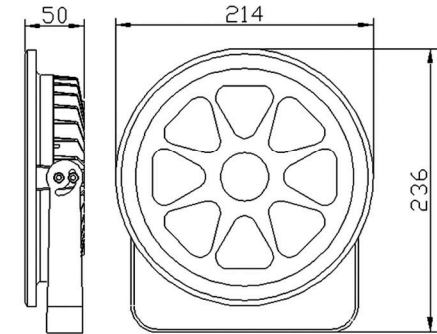

Model No.	LED Brand	Color	Beam	PowerMode	Input	Wiring	Cable	Power	Luminous Flux	Dimention	DrillSize
PL624	CREE	CW,WW, NW,Red, Green,Blue,Amber	10/S20/40/F60	Constant current	350mA	Series	3M 2X0.75mm <sup>2</sup> Cable	24W	2200LM	214XH236XT50	N/A
PL624D	CREE	CW,WW, NW,Red, Green,Blue,Amber	10/S20/40/F60	Constant voltage	24VDC	Parallel	3M 2X0.75mm <sup>2</sup> Cable	26W	2200LM	214XH236XT50	N/A
PL624RGB	CREE	8R+8G+8B	10/S20/40/F60	Constant current	350mA	Series	2x3M 4X0.5mm <sup>2</sup> Cable	24W	N/A	214XH236XT50	N/A
PL624DMX-RGB	CREE	8R+8G+8B	10/S20/40/F60	Constant voltage	24VDC DMX Controller	Parallel	1.1M 4X0.5mm <sup>2</sup> Cable	26W	N/A	214XH236XT50	N/A

DMX decoder in built

\*IES Data support.

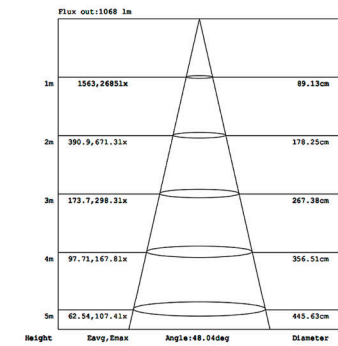
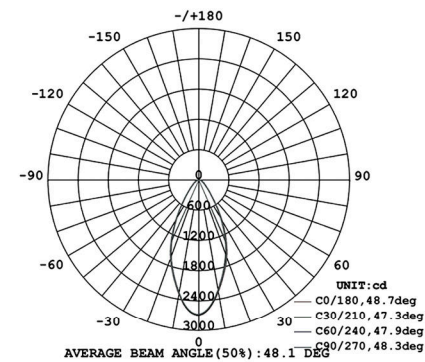

LED Colours

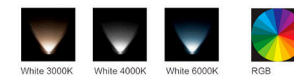



■ PL824

Bar stock aluminum surface mounted projector complete with Integral CREE LED(24pcs)package. Tempered glass, fixture rated to IP67 and configured to 10/20/40/60 degree beam options. NO mechanical joints to light source ensures robust protection against water ingress. Product runs cool meeting all touch temperature requirements. Suitable for the illumination of small/medium trees, building exteriors, columns.



DESCRIPTION

<b>LED Light source</b>	High Power LED
<b>Light Color</b>	RGB,CW,WW,NW,Red,Green,Blue,Amber
<b>Material</b>	Aluminum+SUS316(Bracket)
<b>Optics</b>	10° / S20° / 40° / F60°
<b>Power</b>	24x1W
<b>Power supply</b>	N/A
<b>Dimension</b>	220 X H243 X T55
<b>Weight</b>	2.8KG
<b>IP Rating</b>	IP67
<b>Approvals</b>	CE,RoHS,IP
<b>Ambient temperature</b>	-20°C ~ +45°C
<b>Average life</b>	50,000Hrs
<b>Accessories(Optional)</b>	N/A
<b>Applications</b>	Indoor/Outdoor/Landscape

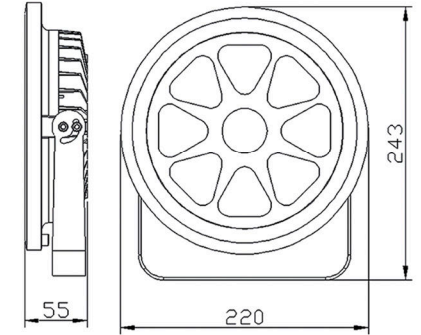

Model No.	LED Brand	Color	Beam	PowerMode	Input	Wiring	Cable	Power	Luminous Flux	Dimension	DrillSize
PL824	CREE	CW,WW, NW,Red Green,Blue,Amber	10/S20/40/F60	Constant current	350mA	Series	3M 2X0.75mm <sup>2</sup> Cable	24W	2200LM	220 X H243X T55	N/A
PL824D	CREE	CW,WW, NW,Red Green,Blue,Amber	10/S20/40/F60	Constant voltage	24VDC	Parallel	3M 2X0.75mm <sup>2</sup> Cable	26W	2200LM	220 X H243 X T55	N/A
PL824RGB	CREE	8R+8G+8B	10/S20/40/F60	Constant current	350mA	Series	2x3M 4X0.5mm <sup>2</sup> Cable	24W	N/A	220 X H243 X T50	N/A

\*IES Data support.

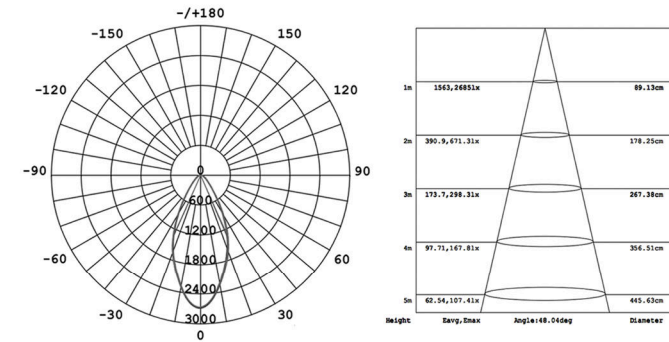

LED Colours

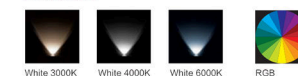



DESCRIPTION

<b>LED Light source</b>	High Power LED
<b>Light Color</b>	RGB,CW,WW,NW,Red,Green,Blue,Amber
<b>Material</b>	SUS316
<b>Optics</b>	S12° / F45°
<b>Power</b>	1W
<b>Power supply</b>	N/A
<b>Dimension</b>	60X60X78
<b>Weight</b>	500g
<b>IP Rating</b>	IP68
<b>Approvals</b>	CE,RoHS,IP
<b>Ambient temperature</b>	-20°C ~ +45°C
<b>Average life</b>	50,000Hrs
<b>Accessories(Optional)</b>	N/A
<b>Applications</b>	Indoor/Outdoor/Landscape/Submersible

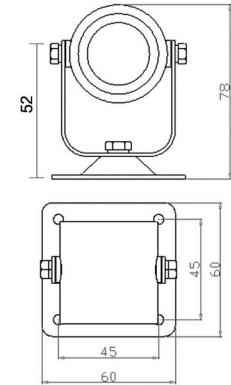

■ PL021

Marine grade 316 stainless steel miniature surface mounted fixture complete with integral CREE LED package. Tempered glass, fixture Rated to IP68 allowing submersion in water thus negating common issues arising from lack of soil drainage. 12/45 degree beam Options. NO mechanical joints to light source ensures robust Protection against water ingress. product runs cool meeting all Touch temperature requirements. Ideal as a surface mounted miniature marker light.

Model No.	LED Brand	Color	Beam	PowerMode	Input	Wiring	Cable	Power	Luminous Flux	Dimension	DrillSize
PL021	CREE	CW,WW, NW,Red, Green,Blue,Amber	12/45	Constant current	350mA	Series	3M 2X0.75mm <sup>2</sup> Cable	1W	100LM	60X60X78	N/A
PL021D	CREE	CW,WW, NW,Red, Green,Blue,Amber	12/45	Constant voltage	24VDC	Parallel	3M 2X0.75mm <sup>2</sup> Cable	1.3W	100LM	60X60X78	N/A
PL021RGB	Edison	RGB	45	Constant current	350mA	Series	2x3M 4X0.5mm <sup>2</sup> Cable	3W	N/A	60X60X78	N/A
PL021DMX-RGB	Edison	RGB	45	Constant voltage	24VDC DMX Controller	Parallel	1.1M 4X0.5mm <sup>2</sup> Cable	3.5W	N/A	60X60X78	N/A

DMX decoder in built

\*IES Data support.

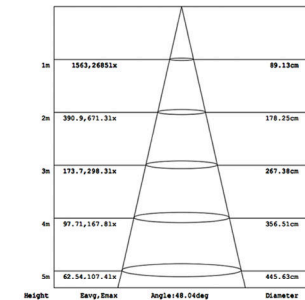
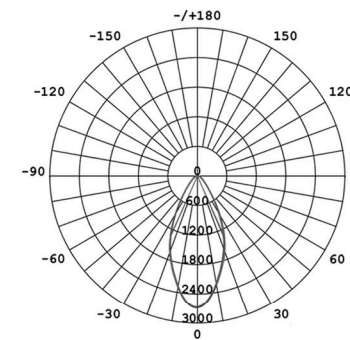
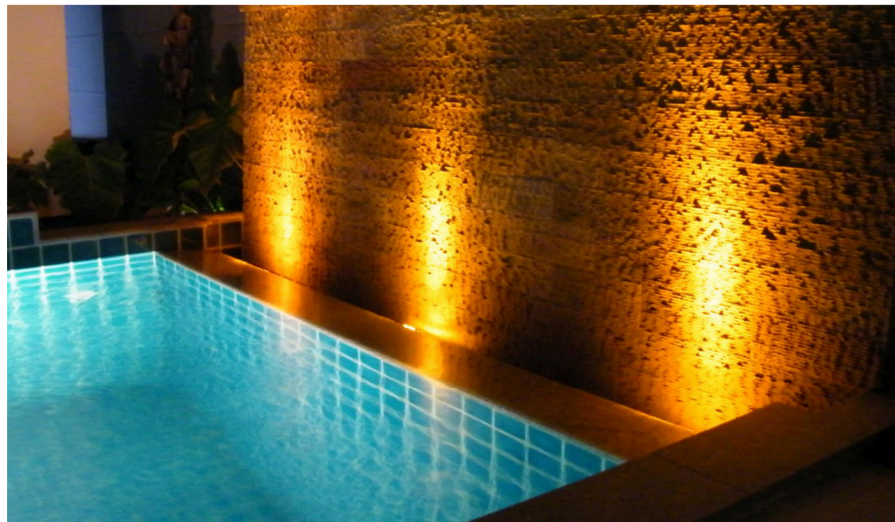

LED Colours

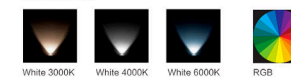



PL023RGB

■ PL023

Marine Grade 316 stainless steel miniature surface mounted fixture Complete with integral CREE LED package glass , fixture Rated to IP68 allowing submersion in water thus negating common Issues arising from lack of soil drainage.20/45/60 degree beam Options.NO mechanical joints to light source ensures robust Protection against water ingress.product runs cool meeting all touch Temperature requirements.Ideal as a surface mounted miniature Marker light.

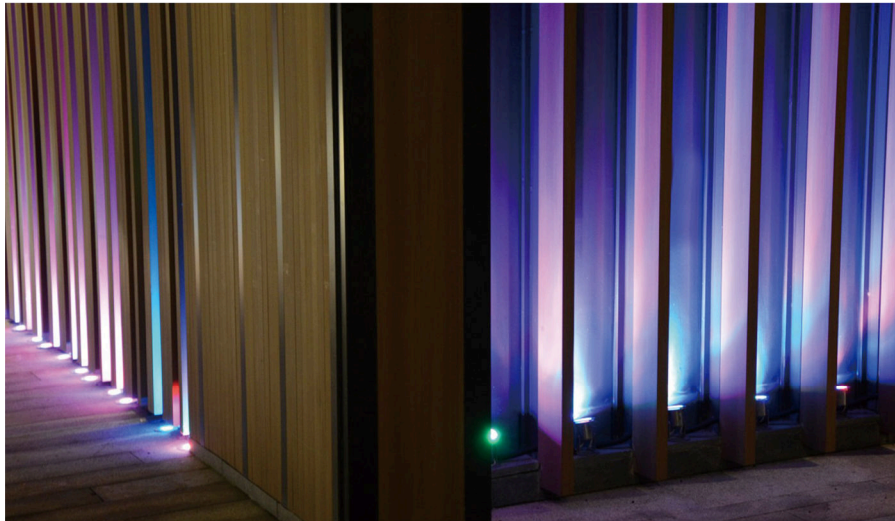

DESCRIPTION

<b>LED Light source</b>	High Power LED
<b>Light Color</b>	RGB,CW,WW,NW,Red,Green,Blue,Amber
<b>Material</b>	SUS316
<b>Optics</b>	S20° / F60°
<b>Power</b>	3x1W
<b>Power supply</b>	N/A
<b>Dimension</b>	70x70x89
<b>Weight</b>	750g
<b>IP Rating</b>	IP68
<b>Approvals</b>	CE,RoHS,IP
<b>Ambient temperature</b>	-20°C ~ +45°C
<b>Average life</b>	50,000Hrs
<b>Accessories(Optional)</b>	N/A
<b>Applications</b>	Indoor/Outdoor/Landscape/Submersible

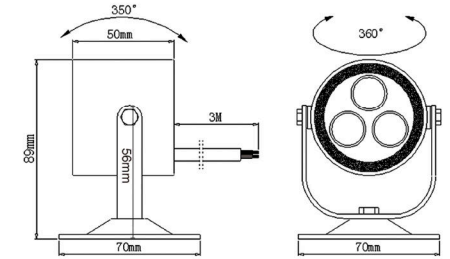

Model No.	LED Brand	Color	Beam	PowerMode	Input	Wiring	Cable	Power	Luminous Flux	Dimension	DrillSize
PL023	CREE	CW,WW, NW,Red Green,Blue,Amber	S20/F60	Constant current	350mA	Series	3M 2X0.75mm <sup>2</sup> Cable	3W	300LM	70x70x89	N/A
PL023D	CREE	CW,WW, NW,Red Green,Blue,Amber	S20/F60	Constant voltage	24VDC	Parallel	3M 2X0.75mm <sup>2</sup> Cable	3.5W	300LM	70x70x89	N/A
PL023RGB	Edison	RGB	10/20/45/60	Constant current	350mA	Series	2x3M 4X0.5mm <sup>2</sup> Cable	9W	N/A	70x70x89	N/A
PL023DMX-RGB	Edison	RGB	45	Constant voltage	24VDC DMX Controller	Parallel	1.1M 4X0.5mm <sup>2</sup> Cable	3.5W	N/A	70x70x89	N/A

DMX decoder in built

\*IES Data support.

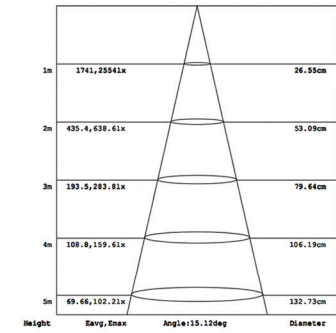
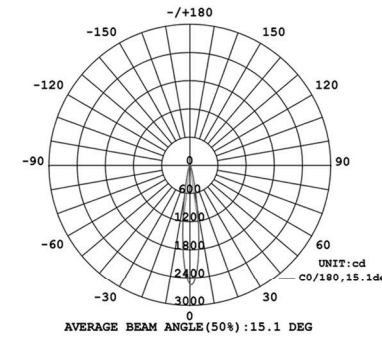

LED Colours

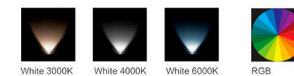



■ PL023-2L

Marine grade 316 stainless surface mounted fixture complete With integral CREE LED package.Tempered glass,fixture rated to IP68 allowing submersion.20/60 degree beam options,product Functions with 350 mA constant current driver.NO mechanical joints to light source ensures robust protection against water ingress.Product runs cool meeting all touch temperature requirements.Elevated light source(500mm)allows for a down light effect to be Created to paths and boundaries.



DESCRIPTION

<b>LED Light source</b>	High Power LED
<b>Light Color</b>	RGB,CW,WW,NW,Red,Green,Blue,Amber
<b>Material</b>	SUS316
<b>Optics</b>	S20° / F60°
<b>Power</b>	3W
<b>Power supply</b>	N/A
<b>Dimention</b>	N/A
<b>Weight</b>	N/A
<b>IP Rating</b>	IP68
<b>Approvals</b>	CE,RoHS,IP
<b>Ambient temperature</b>	-20°C ~ +45°C
<b>Average life</b>	50,000Hrs
<b>Accessories(Optional)</b>	N/A
<b>Applications</b>	Indoor / Outdoor / Landscape / Submersible

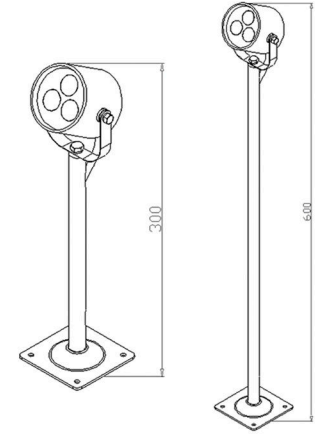

Model No.	LED Brand	Color	Beam	PowerMode	Input	Wiring	Cable	Power	Luminous Flux	Dimention	DrillSize
PL023-2L	CCREE	RGB,CW,WW, NW Red,Green,Blue,Amber	S20/F60	Constant current	350mA	Series	3M 2X0.75mm² Cable	3W	300LM	70x70x300	N/A
PL023D-2L	CREE	CW,WW, NW Red,Green,Blue,Amber	S20/F60	Constant voltage	12/24VDC	Parallel	3M 2X0.75mm² Cable	3.5W	300LM	70x70x300	N/A
PL023-5L	CREE	RGB,CW,WW, NW Red,Green,Blue,Amber	S20/F60	Constant current	350mA	Series	3M 2X0.75mm² Cable	3W	300LM	70x70x600	N/A
PL023D-5L	CREE	CW,WW, NW Red,Green,Blue,Amber	S20/F60	Constant voltage	12/24VDC	Parallel	3M 2X0.75mm² Cable	3.5W	300LM	70x70x600	N/A

\*IES Data support.

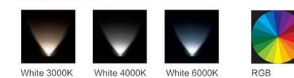
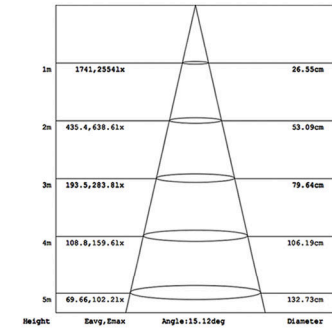
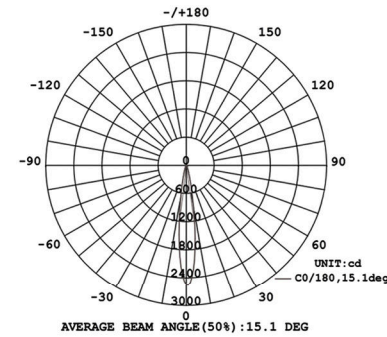





DESCRIPTION

<b>LED Light source</b>	High Power LED
<b>Light Color</b>	RGB,CW,WW,NW,Red,Green,Blue,Amber
<b>Material</b>	SUS316
<b>Optics</b>	S10° / F40°
<b>Power</b>	6W
<b>Power supply</b>	N/A
<b>Dimention</b>	85X85X104
<b>Weight</b>	1.05kg
<b>IP Rating</b>	IP68
<b>Approvals</b>	CE,RoHS,IP
<b>Ambient temperature</b>	-20°C ~ +45°C
<b>Average life</b>	50,000Hrs
<b>Accessories(Optional)</b>	N/A
<b>Applications</b>	Indoor / Outdoor / Landscape / Submersible

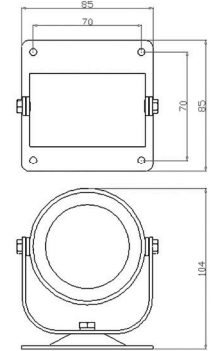

■ PL026

Marine Grade 316 stainless steel miniature surface mounted fixture complete with integral CREE LED package. Tempered glass, fixture Rated to IP 68 allowing submersion in water thus negating common issues arising from lack of soil drainage. 10/40 degree beam Options .NO mechanical joints to light source ensures robust Protection against water ingress .product runs cool meeting all Touch temperature requirements. Ideal as a surface mounted miniature marker light.



Model No.	LED Brand	Color	Beam	PowerMode	Input	Wiring	Cable	Power	Luminous Flux	Dimention	DrillSize
PL026	CREE	CW,WW, NW,Red Green,Blue,Amber	S10/F40	Constant current	350mA	Series	3M 2X0.75mm <sup>2</sup> Cable	6W	500LM	85X85X104	N/A
PL026D	CREE	CW,WW, NW,Red Green,Blue,Amber	S10/F40	Constant voltage	24VDC	Parallel	3M 2X0.75mm <sup>2</sup> Cable	6.5W	500LM	85X85X104	N/A
PL026RGB	CREE	2R+2G+2B	S10/F40	Constant current	350mA	Series	2x3M 4X0.5mm <sup>2</sup> Cable	6W	N/A	85X85X104	N/A
PL026DMX-RGB	CREE	2R+2G+2B	S10/F40	Constant voltage	24VDC DMX Controller	Parallel	1.1M 4X0.5mm <sup>2</sup> Cable	6.5W	N/A	85X85X104	N/A
PL026DMX-RGB	Edison	RGB(Fullcolor)	S10/F40	Constant voltage	24VDC DMX Controller	Parallel	1.1M 4X0.5mm <sup>2</sup> Cable	6.5W	N/A	85X85X104	N/A
PL026DMX-RGBW	Edison	RGBW(Fullcolor)	S10/F40	Constant voltage	24VDC DMX Controller	Parallel	1.1M 4X0.5mm <sup>2</sup> Cable	6.5W	N/A	85X85X104	N/A

DMX decoder in built

\*IES Data support.

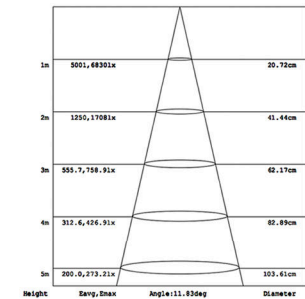
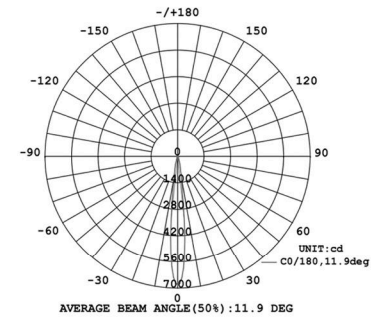

LED Colours

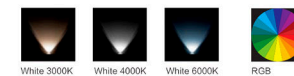

# LINE LIGHTING

SPECIALIZED MANUFACTURER  
LED LIGHTING PRODUCTS



DESCRIPTION

- LED Light source** SMD LED
- Light Color** RGB,CW,WW,NW,Red,Green,Blue,Amber
- Material** Aluminium
- Optics** 120°
- Power** 12W / 6.5W
- Power supply** N/A
- Dimension** 1000X45X50 / 500X45X50
- Weight** N/A
- IP Rating** IP65
- Approvals** CE,RoHS
- Ambient temperature** -20°C ~ +45°C
- Average life** 50,000Hrs
- Accessories(Optional)** N/A
- Applications** Indoor/Outdoor
- Optional brand** OSRAM

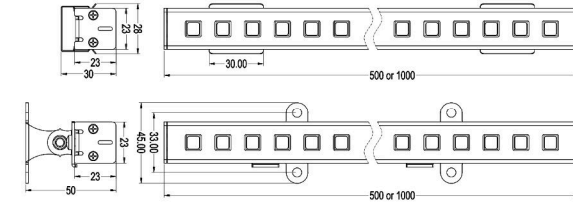

■ EU2009

120 degree optic as standard for light projection. Aluminum construction rated to IP65, suitable for exterior applications. Supplied with optional mounting clips allowing for the fixture to be angled.

Model No.	LED Brand	Color	Beam	PowerMode	Input	Wiring	Cable	Power	Luminous Flux	Dimension
EU2009-1M	OSRAM	CW,WW,NW	120°	Constant voltage	24VDC	Parallel	0.2M 2X1.0mm <sup>2</sup> Plug	12W	1000LM	1000X45X50
EU2009-0.5M	OSRAM	CW,WW,NW	120°	Constant voltage	24VDC	Parallel	0.2M 2X1.0mm <sup>2</sup> Plug	6.5W	500LM	500X45X50
EU2009DMX-1M	EDISON	RGB	120°	Constant voltage	24VDC DMX contronller	Parallel	0.2M 4X0.5mm <sup>2</sup> Plug	12W	N/A	1000X45X50
EU2009DMX-0.5M	EDISON	RGB	120°	Constant voltage	24VDC DMX contronller	Parallel	0.2M 4X0.5mm <sup>2</sup> Plug	6.5W	N/A	500X45X50

DMX decoder in built

\*IES Data support.

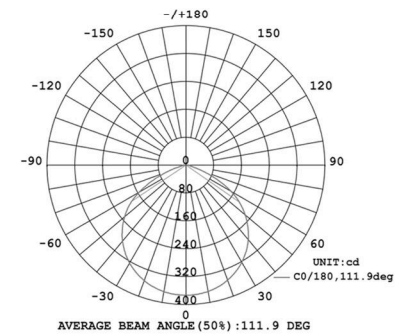
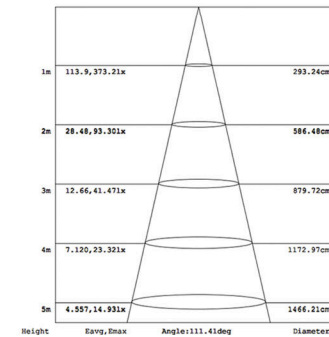
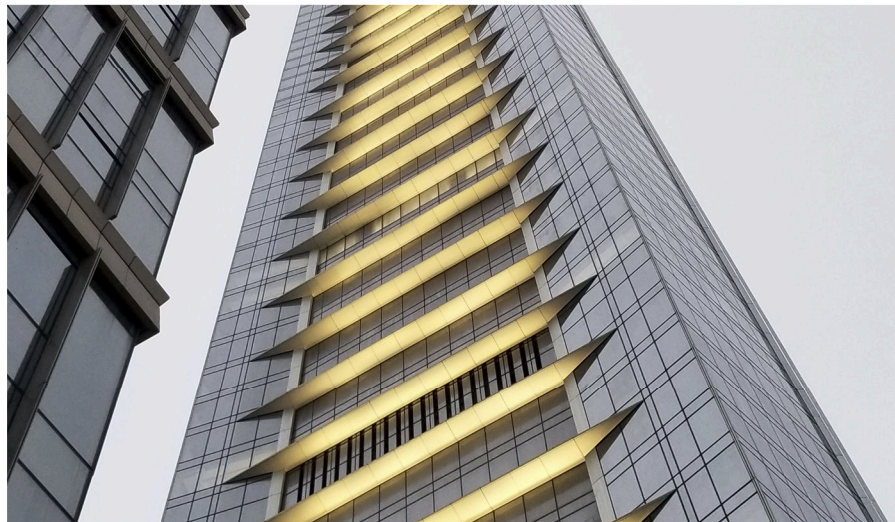

LED Colors

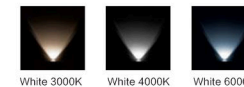



■ EU2009HP

10/20/30/45/60/10x40 degree optic as standard for light projection. Aluminum construction rated to IP65, suitable for exterior applications. Supplied with optional mounting clips allowing for the fixture to be angled.

DESCRIPTION

- LED Light source** High Power LED
- Light Color** RGB,CW,WW,NW,Red,Green,Blue,Amber
- Material** Aluminum
- Optics** 10°/20°/30°/45°/60°/10X40°
- Power** 18W / 9W
- Power supply** N/A
- Dimension** 1000X45X50 / 500X45X50
- Weight** N/A
- IP Rating** IP65
- Approvals** CE,RoHS
- Ambient temperature** -20°C ~ +45°C
- Average life** 50,000Hrs
- Accessories(Optional)** N/A
- Applications** Indoor/Outdoor
- Optional brand** CREE

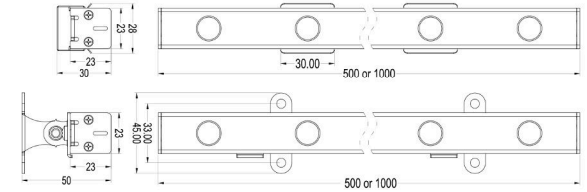

Model No.	LED Brand	Color	Beam	PowerMode	Input	Wiring	Cable	Power	Luminous Flux	Dimension
EU2009HP-1M	CREE	CW,WW,NW,Red Green,Blue,Amber	10°/20°/30°/45° /60°/10X40°	Constant voltage	24VDC	Parallel	0.2M 2X1.0mm <sup>2</sup> Plug	18W	1000LM	1000X45X50
EU2009HP-0.5M	CREE	CW,WW,NW,Red Green,Blue,Amber	10°/20°/30°/45° /60°/10X40°	Constant voltage	24VDC	Parallel	0.2M 2X1.0mm <sup>2</sup> Plug	9W	500LM	500X45X50

\*IES Data support.

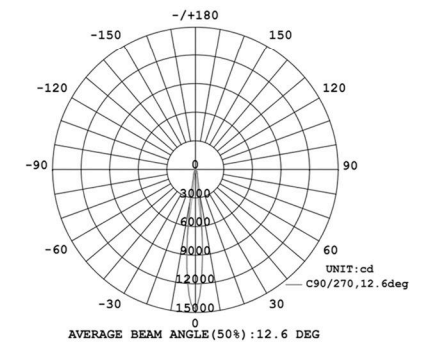
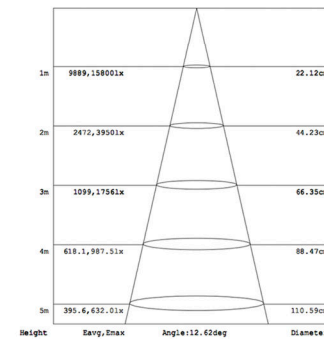

LED Colors

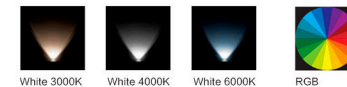



■ EU2001

Square recessed fixture complete with integral CREE LED package and 20/60 degree beam option. Tempered glass, Aluminum option with construction rated to IP66. Small Product footprint ensures versatile application. Easy to install into the panels.

DESCRIPTION

<b>LED Light source</b>	High Power LED
<b>Light Color</b>	CW,WW,NW,Red,Green,Blue,Amber,RGB,RGBW
<b>Material</b>	Aluminum
<b>Optics</b>	S20° / F60°
<b>Power</b>	2W
<b>Power supply</b>	24VDC
<b>Dimension</b>	L69xW44xH41
<b>Weight</b>	150g
<b>IP Rating</b>	IP66
<b>Approvals</b>	CE,RoHS
<b>Ambient temperature</b>	-20°C ~ +45°C
<b>Average life</b>	50,000Hrs
<b>Accessories(Optional)</b>	N/A
<b>Applications</b>	Indoor/Outdoor

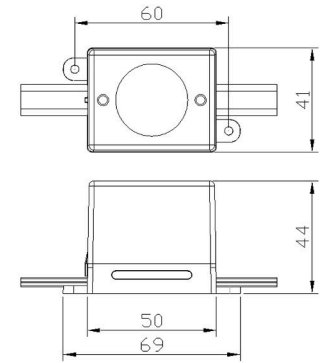

Model No.	LED Brand	Color	Beam	PowerMode	Input	Wiring	Cable	Power	Luminous Flux	Dimension	DrillSize
EU2001D	CREE	CW,WW,NW,Red,Green,Blue,Amber	S20° / F60°	Constant voltage	24VDC	Parallel	0.5M 2X1.0mm <sup>2</sup> Cable	2W	150LM	L69xW44xH41	N/A
EU2001DMX	CREE	CW,WW,NW,Red,Green,Blue,Amber	S20° / F60°	Constant voltage DMX	24VDC DMX	Parallel	0.5M 2X1.0mm <sup>2</sup> +4*0.2mm Cable	2W	150LM	L69xW44xH41	N/A
EU2001DMX	EDISON	RGB,RGBW	S20° / F60°	Constant voltage DMX	24VDC DMX	Parallel	0.5M 2X1.0mm <sup>2</sup> +4*0.2mm Cable	3W	50LM	L69xW44xH41	N/A

DMX decoder in built

\*IES Data support.

\*Length could be customized

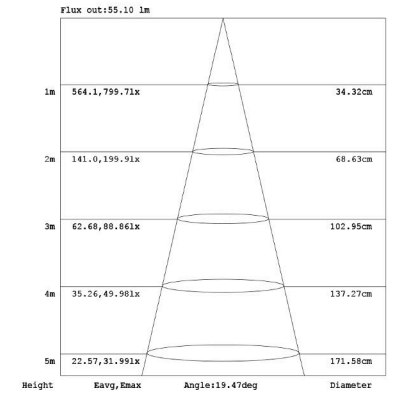
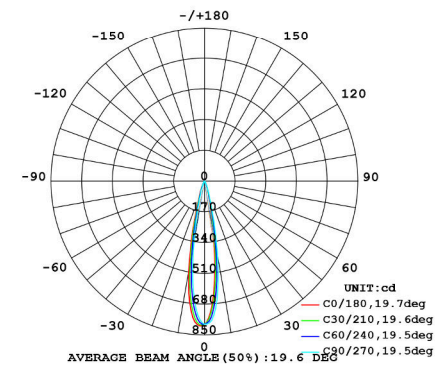

LED Colours

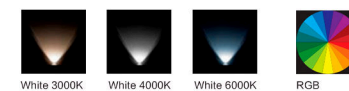



■ EU2006

Finished to a high standard using anodized aluminum makes it suitable for both indoor and outdoor applications, construction rated to IP67 and configured to 3 degree beam angle.

DESCRIPTION

- LED Light source** High Power LED
- Light Color** CW,WW,NW
- Material** Aluminum
- Optics** 3°
- Power** 7W
- Power supply** N/A
- Dimension** D60XH76
- Weight** N/A
- IP Rating** IP67
- Approvals** CE,RoHS
- Ambient temperature** -20°C ~ +45°C
- Average life** 50,000Hrs
- Accessories(Optional)** N/A
- Applications** Indoor/Outdoor/Landscape
- Optional brand** CREE

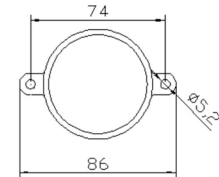
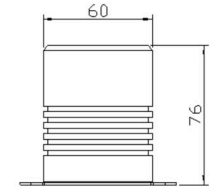

Model No.	LED Brand	Color	Beam	PowerMode	Input	Wiring	Cable	Power	Luminous Flux	Dimension	DrillSize
EU2006	CREE	CW,WW,NW	3°	Constant current	600mA@11.3VDC	Series	1.1M 2X0.75mm <sup>2</sup> Cable	7W	600LM	D60XH76	
EU2006D	CREE	CW,WW,NW	3°	Constant voltage	24VDC	Parallel	1.1M 2X0.75mm <sup>2</sup> Cable	7.5W	600LM	D60XH76	
EU2006DMX	CREE	CW,WW,NW	3°	Constant voltage	24VDC	Parallel	1.1M 4X0.5mm <sup>2</sup> Cable	7.5W	600LM	D60XH76	

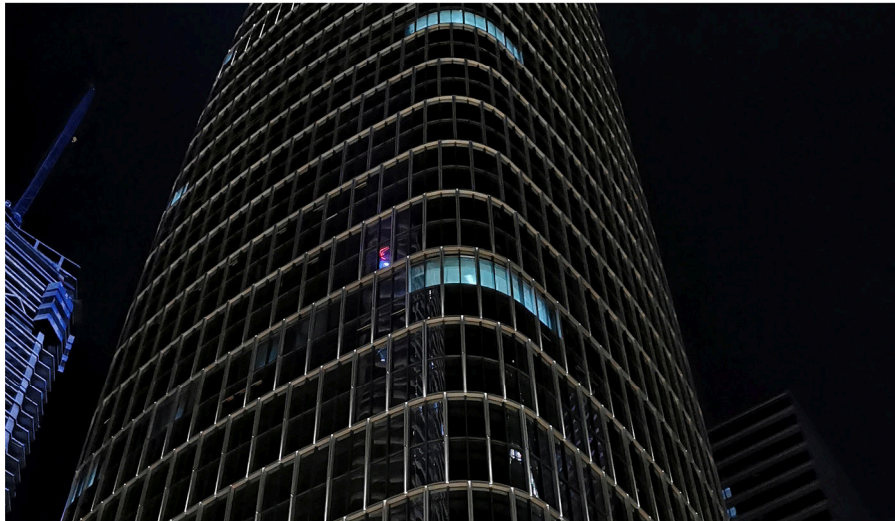

\*IES Data support.

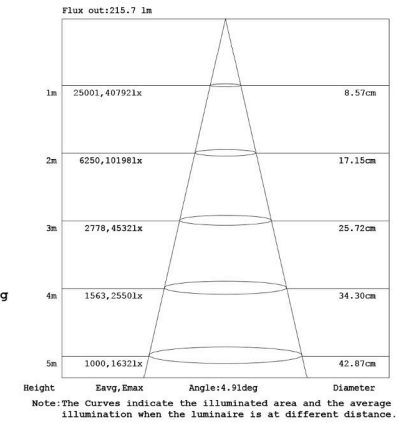
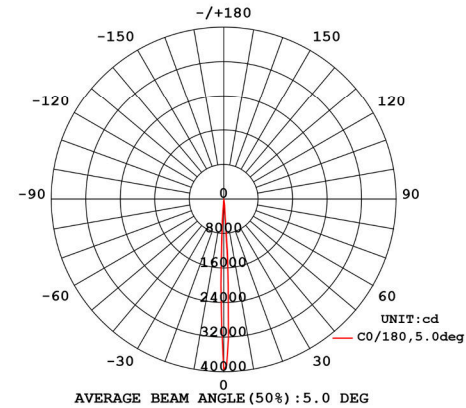

LED Colours

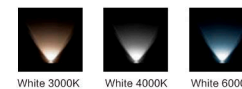



■ LL700

Recessed linear fixture rated to IP67. Wall/ floor -recessed luminaire for use with fluorescent lamps and LEDs. Tempered glass with integrated CREE XPE LED chipset. Luminaire ready for pass-through wiring.



DESCRIPTION

- LED Light source** High Power LED
- Light Color** RGB,CW,WW,NW,Red,Green,Blue,Amber
- Material** Aluminum
- Optics** 10° / 20° / 40° / 60°
- Power** N/A
- Power supply** N/A
- Dimension** 1000X45XH56
- Weight** 1.8KG
- IP Rating** IP67
- Approvals** CE,RoHS,IP
- Ambient temperature** -20°C ~ +45°C
- Average life** 50,000Hrs
- Accessories(Optional)** N/A
- Applications** Indoor/Outdoor

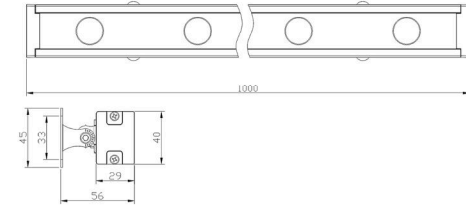

Model No.	LED Brand	Color	Beam	PowerMode	Input	Wiring	Cable	Power	Luminous	Dimension	DrillSize
LL700D-1M-12	CREE	CW,WW, NW,Red Green,Blue,Amber	10/S20/40/F60	Constant voltage	24VDC	Parallel	0.5M 2X0.75mm <sup>2</sup> Cable or 0.2M Plug	13W	1200LM	1000X45XH56	N/A
LL700D-1M-24	CREE	CW,WW, NW,Red Green,Blue,Amber	10/S20/40/F60	Constant voltage	24VDC	Parallel	0.5M 2X0.75mm <sup>2</sup> Cable or 0.2M Plug	26W	2400LM	1000X45XH56	N/A
LL700D-0.5M-6	CREE	CW,WW, NW,Red Green,Blue,Amber	10/S20/40/F60	Constant voltage	24VDC	Parallel	0.5M 2X0.75mm <sup>2</sup> Cable or 0.2M Plug	6.5W	600LM	500X45XH56	N/A
LL700D-0.5M-12	CREE	CW,WW, NW,Red Green,Blue,Amber	10/S20/40/F60	Constant voltage	24VDC	Parallel	0.5M 2X0.75mm <sup>2</sup> Cable or 0.2M Plug	13W	1200LM	500X45XH56	N/A
LL700D-0.3M-4	CREE	CW,WW, NW,Red Green,Blue,Amber	10/S20/40/F60	Constant voltage	24VDC	Parallel	0.5M 4X0.5mm <sup>2</sup> Cable or 0.2M Plug	4.5W	400LM	300X45XH56	N/A
LL700D-1M-12-M	OSRAM	CW,WW, NW,Red Green,Blue,Amber	120	Constant voltage	24VDC	Parallel	0.5M 2X0.75mm <sup>2</sup> Cable or 0.2M Plug	13W	1200LM	1000X45XH56	N/A
LL700-1M-12-DMX	CREE	CW,WW, NW, Red,Green,Blue,Amber	10/S20/40/F60	Constant voltage	24VDC DMX Controller	Parallel	0.5M 4X0.5mm <sup>2</sup> Cable or 0.2M Plug	13W	1200LM	1000X45XH56	N/A
LL700-1M-24-DMX	CREE	CW,WW, NW, Red,Green,Blue,Amber	10/S20/40/F60	Constant voltage	24VDC DMX Controller	Parallel	0.5M 4X0.5mm <sup>2</sup> Cable or 0.2M Plug	26W	2400LM	1000X45XH56	N/A
LL700-1M-16-DMX-RGBW	CREE	4R+4G+4B+4W	10/S20/40/F60	Constant voltage	24VDC DMX Controller	Parallel	0.5M 4X0.5mm <sup>2</sup> Cable or 0.2M Plug	17W	N/A	1000X45XH56	N/A

DMX decoder is built

\*IES Data support.  
\*Length could be customized

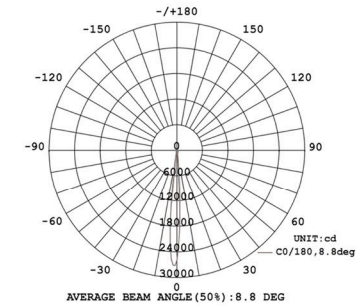
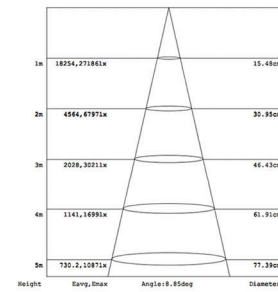

LED Colours

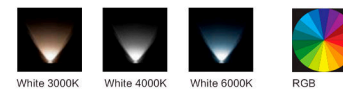

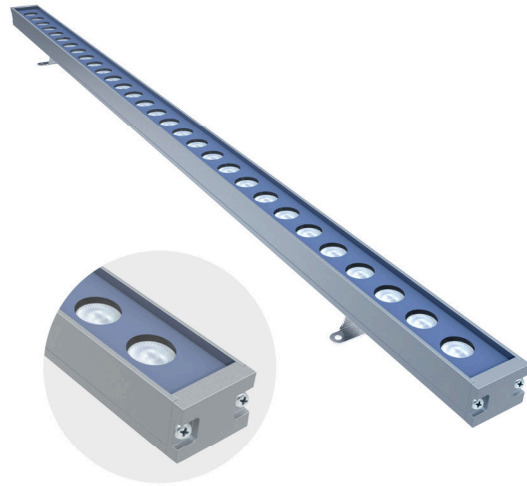

■ LL710

Recessed linear fixture rated to IP67. Wall/ floor-recessed luminaire for use with fluorescent lamps and LEDs. Tempered glass with integrated CREE XPE LED chipset. Luminaire ready for pass-through wiring.

DESCRIPTION

<b>LED Light source</b>	High Power LED
<b>Light Color</b>	RGB,CW,WW,NW,Red,Green,Blue,Amber
<b>Material</b>	Aluminum
<b>Optics</b>	15° / 20° / 30° / 45° / 60°
<b>Power</b>	12W
<b>Power supply</b>	24VDC
<b>Dimension</b>	1000X40XH55
<b>Weight</b>	N/A
<b>IP Rating</b>	IP67
<b>Approvals</b>	CE,RoHS,IP
<b>Ambient temperature</b>	-20°C ~ +45°C
<b>Accessories(Optional)</b>	N/A
<b>Applications</b>	Indoor/Outdoor

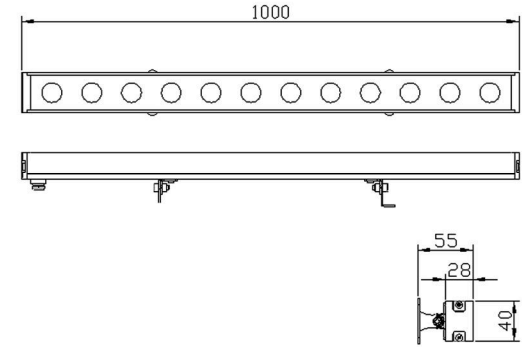

MODEL NO.	LED Brand	Color	BEAM	PowerMode	Input	Wiring	Power	Luminous	Dimension	DrillSize
LL710D	CREE	CW,WW, NW,Red Green,Blue,Amber	15/S20/30/45/F60	Constant voltage	24VDC	Parallel	12W	800LM	1000X40XH55	N/A
LL710DM	OSRAM	CW,WW, NW,Red Green,Blue,Amber	120	Constant voltage	24VDC	Parallel	12W	500LM	1000X40XH55	N/A
LL710DMX-RGB	CREE	4R+4G+4B	15/S20/30/45/F60	Constant voltage	24VDC DMX Controller	Parallel	12W	N/A	1000X40XH55	N/A
LL710-1M-12W -DMX-RGB	Edison	RGB(FullColor)	15/S20/30/45/F60	Constant voltage	24VDC DMX Controller	Parallel	12W	N/A	1000X40XH55	N/A

DMX decoder in built

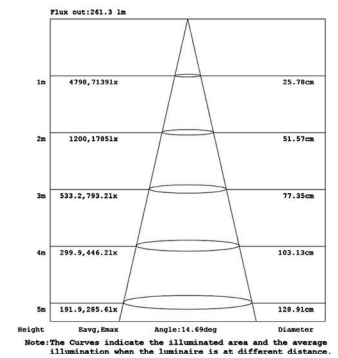
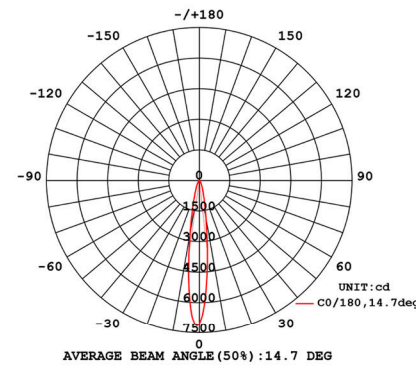

LED Colours

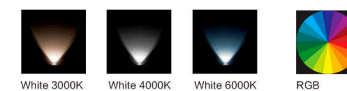





# LED COMPONENTS

SPECIALIZED MANUFACTURER  
LED LIGHTING PRODUCTS



■ LED03

A 50mm MR16 LED for retrofitting into existing LV housings, including ground lights, down lights, and wall lights. Tempered glass, The three high-power LEDs within this 3W unit come in a range of LED colors and emit the same intensity of light as a 20w halogen. It has a short rear heat sink for fitting into shallow housings, and a choice of flood(60°) or spot(20°) lens formats.

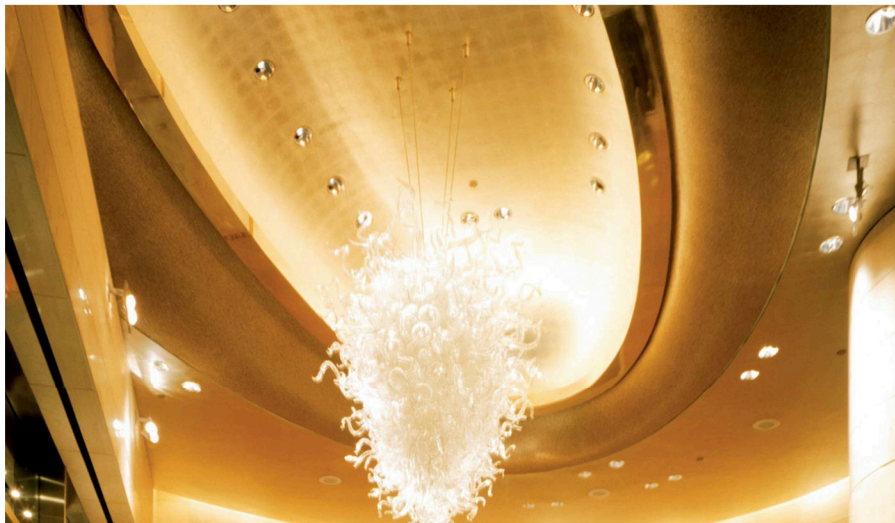

DESCRIPTION

<b>LED Light source</b>	High Power LED
<b>Light Color</b>	RGB,CW,WW,NW,Red,Green,Blue,Amber
<b>Material</b>	Aluminum
<b>Optics</b>	S20° / F60°
<b>Power</b>	3W
<b>Power supply</b>	N/A
<b>Dimension</b>	D50X25
<b>Weight</b>	100g
<b>IP Rating</b>	IP40
<b>Approvals</b>	CE,RoHS,IP
<b>Average life</b>	50,000Hrs
<b>Accessories(Optional)</b>	N/A
<b>Applications</b>	Indoor

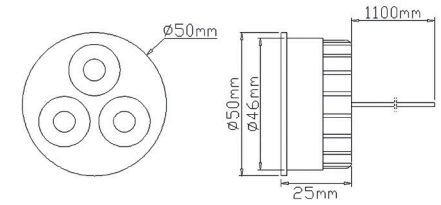

Model No.	LED Brand	Color	Beam	PowerMode	Input	Wiring	Cable	Power	Luminous Flux	Dimension	DrillSize
LED03	CREE	CW,WW, NW,Red Green,Blue,Amber	S20/F60	Constant current	350mA	Series	1.1M 2X24AWG Cable	3W	300LM	D50X25	D47
LED03RGB	CREE	RGB	S20/F60	Constant current	RGB350mA	Series	2x1.1M 4X24AWG Plug	3W	N/A	D50X25	D47

\*IES Data support.

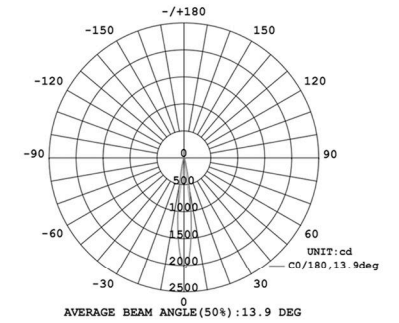
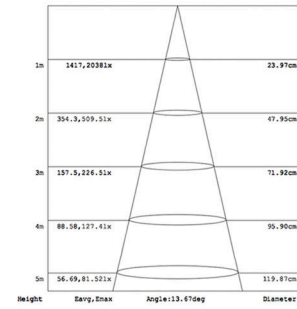

LED Colours

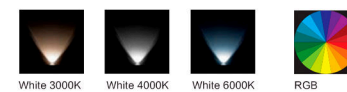



■ LED09

This low-energy, 50mm MR16 LED unit is a cost-saving alternative to expensive and maintenance hungry LV and GU halogens. It's a zero maintenance replacement that fits straight into existing Lv housings, including ground lights, down lights, and wall lights. Tempered glass. The three high-power LEDs within this 9w lamp emit more light than a 35W halogen, yet they run at a fraction of the cost.

DESCRIPTION

<b>LED Light source</b>	High Power LED
<b>Light Color</b>	RGB,CW,WW,NW,Red,Green,Blue,Amber
<b>Material</b>	Aluminum
<b>Optics</b>	S20° / F60°
<b>Power</b>	9W
<b>Power supply</b>	N/A
<b>Dimension</b>	D50X55
<b>Weight</b>	150g
<b>IP Rating</b>	IP40
<b>Approvals</b>	CE,RoHS,IP
<b>Average life</b>	50,000Hrs
<b>Applications</b>	Indoor

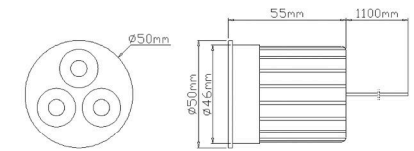

Model No.	LED Brand	Color	Beam	PowerMode	Input	Wiring	Cable	Power	Luminous Flux	Dimension	DrillSize
LED09	CREE	CW,WW, NW,Red,Green,Blue,Amber	S20/F60	Constant current	700mA	Series	1.1M 2X24AWG Cable	9W	N/A	D50X55	D47
LED09RGB	EDISON	RGB	45	Constant current	RGB350mA	Series	1.1M 4X24AWG Plug	9W	N/A	D50X55	D47

\*IES Data support.

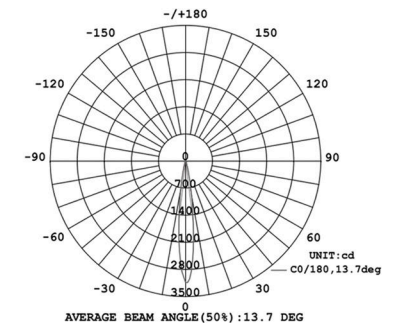
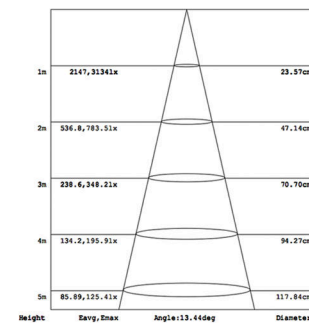

LED Colours

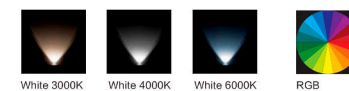



# WALL LIGHT

SPECIALIZED MANUFACTURER  
LED LIGHTING PRODUCTS

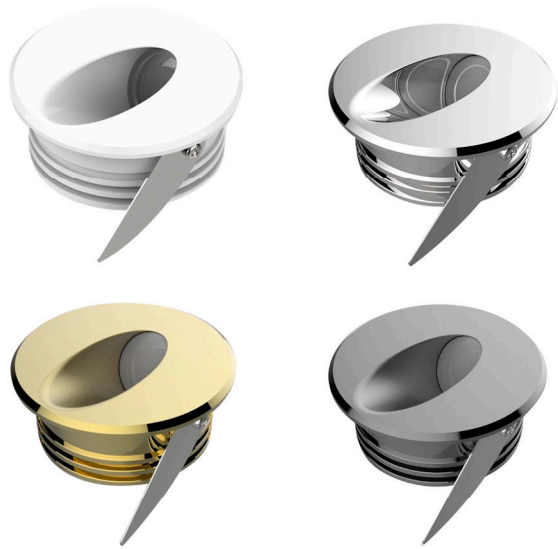

■ EU1808

Miniature recessed fixture complete with integral CREE LED package and 60 degree beam option. Aluminum surface mounted projector. Tempered glass with construction rated to IP44 with single aperture for asymmetric emission. Product footprint of 64mm diameter ensures versatile application. Easy to install into the panels.

DESCRIPTION

<b>LED Light source:</b>	High Power LED
<b>Light Color:</b>	CW,WW,NW,Red,Green,Blue,Amber
<b>Material:</b>	Aluminum
<b>Optics:</b>	60°
<b>Power:</b>	1W/3W
<b>Power supply:</b>	N/A
<b>Dimension:</b>	D64X43
<b>Weight:</b>	170g
<b>IP Rating:</b>	IP44
<b>Approvals:</b>	CE, RoHS
<b>Ambient temperature:</b>	-20°C~+45°C
<b>Average Life:</b>	50,000Hrs
<b>Accessories(Optional):</b>	N/A
<b>Applications:</b>	Indoor

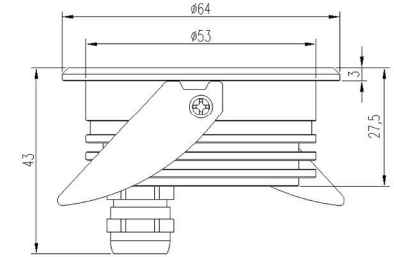

Model No.	LED Brand	Color	Beam	PowerMode	Input	Wiring	Cable	Power	Luminous Flux	Dimension	DrillSize
EU1808	CREE	CW,WW,NW,Red,Green,Blue,Amber	60°	Constant current	350mA	Series	0.5m 2*0.75 Cable	H05RN-F 1W	95LM	D64X43	D60
EU1808-3W	CREE	CW,WW,NW,Red,Green,Blue,Amber	60°	Constant current	700mA	Series	0.5m 2*0.75 Cable	H05RN-F 3W	160LM	D64X43	D60

\*IES Data support.

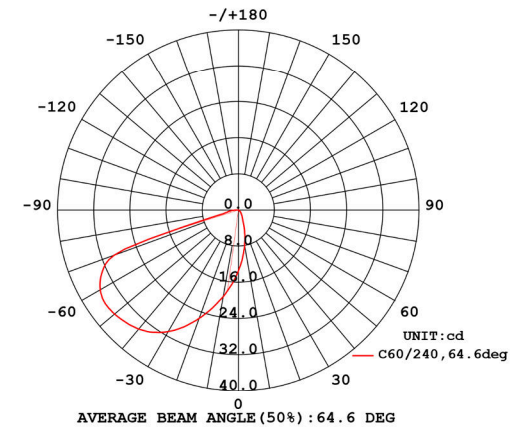
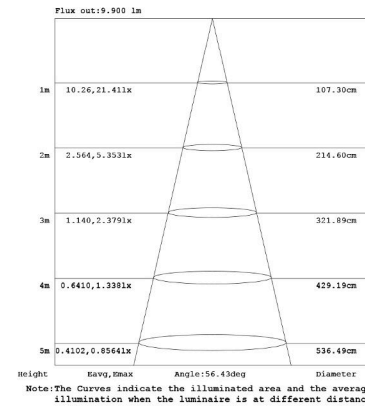

LED Colours

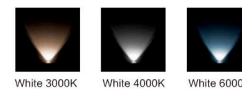



DESCRIPTION

<b>LED Light source</b>	LED
<b>Light Color</b>	CW,WW,NW,Red,Green,Blue,Amber
<b>Material</b>	Aluminum
<b>Optics</b>	70°
<b>Power</b>	1W / 0.3W
<b>Power supply</b>	350mA/24VDC
<b>Dimension</b>	D24XH25
<b>Weight</b>	30g
<b>IP Rating</b>	IP65
<b>Approvals</b>	CE,RoHS
<b>Ambient temperature</b>	-20°C ~ +45°C
<b>Average life</b>	50,000Hrs
<b>Accessories(Optional)</b>	YES
<b>Applications</b>	Indoor

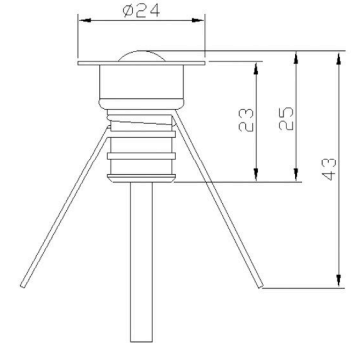

■ EU1820

Miniature recessed fixture complete with integral OSRAM LED package and 70 degree beam option. IP65 wall light is made of Aluminum. Frosted optic serves to minimize glare coupled with a diffuse beam distribution. Small Product footprint ensures versatile application. Easy to install into the panels.

Model No.	LED Brand	Color	Beam	PowerMode	Input	Wiring	Cable	Power	Luminous Flux	Dimension	DrillSize
EU1820	OSRAM	CW,WW,NW,Red,Green,Blue,Amber	70 °	Constant current	350mA	Series	0.5M 2X0.4mm <sup>2</sup> Cable	1W	60LM	D24XH25	D17
EU1820D	OSRAM	CW,WW,NW,Red,Green,Blue,Amber	70 °	Constant voltage	24VDC	Parallel	0.5M 2X0.4mm <sup>2</sup> Cable	1W	60LM	D24XH25	D17
EU1820D-0.3	OSRAM	CW,WW,NW,Red,Green,Blue,Amber	70 °	Constant voltage	24VDC	Parallel	0.5M 2X0.4mm <sup>2</sup> Cable	0.3W	20LM	D24XH25	D17

\*IES Data support.

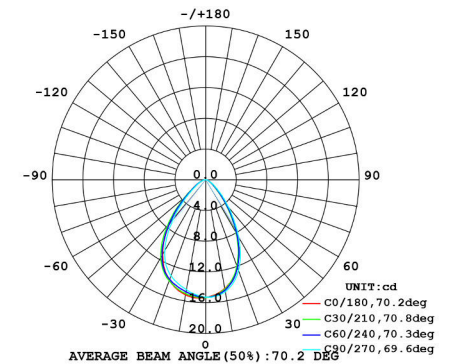
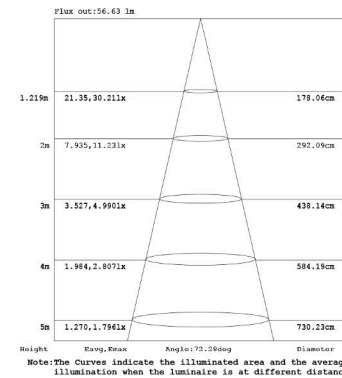
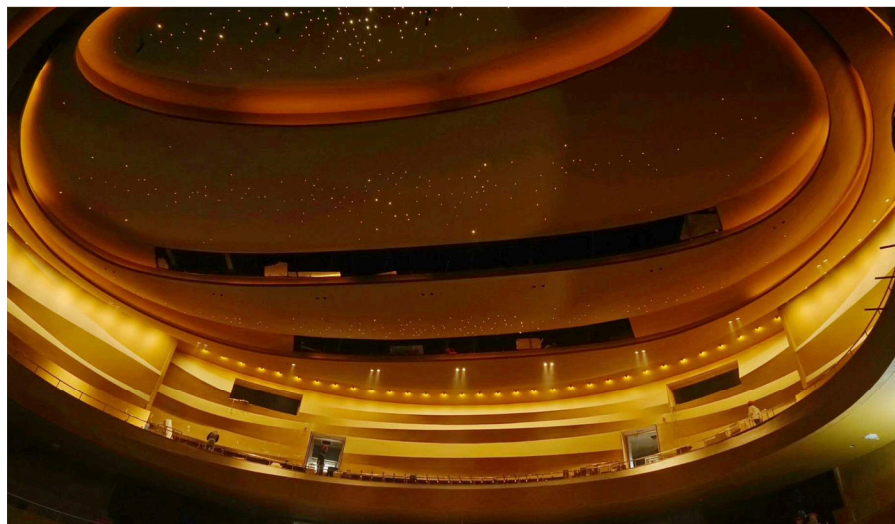

LED Colours

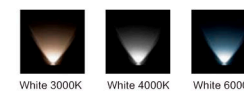



■ ML101

A modern day and elegant LED decorative mini-light, it is designed to add style to floors, bars, walls and ceilings. Walkover and IP68 rated. The clever and stylish design of the light output means no glare even when looking directly at it, making this product perfect for stair facings. Using only 1W of energy makes running costs incredibly low, whilst visual impact is high. Tempered glass. Made from marine grade stainless steel and IP rated to 68 ensures you can use this product indoors or out.

DESCRIPTION

<b>LED Light source</b>	High Power LED
<b>Light Color</b>	RGB,CW,WW,NW,Red,Green,Blue,Amber
<b>Material</b>	SUS316
<b>Optics</b>	N/A
<b>Power</b>	1W
<b>Power supply</b>	N/A
<b>Dimension</b>	D35X28
<b>Weight</b>	70g
<b>IP Rating</b>	IP68
<b>Approvals</b>	CE,RoHS,IP
<b>Ambient temperature</b>	-20°C ~ +45°C
<b>Average life</b>	50,000Hrs
<b>Accessories(Optional)</b>	N/A
<b>Applications</b>	Indoor/Outdoor/Landscape/Submersible

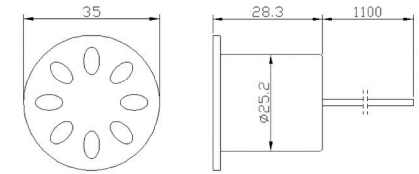

Model No.	LED Brand	Color	Beam	PowerMode	Input	Wiring	Cable	Power	Luminous Flux	Dimension	DrillSize
ML101	CREE	CW,WW, NW,Red,Green,Blue,Amber	N/A	Constant current	350mA	Series	1.1M 2X0.4mm <sup>2</sup> Cable	1W	N/A	D35X28	D26
ML101D	CREE	CW,WW, NW,Red,Green,Blue,Amber	N/A	Constant voltage	24VDC	Parallel	1.1M 2X0.4mm <sup>2</sup> Cable	1.3W	N/A	D35X28	D26
ML101RGB	EDISON	RGB	N/A	Constant voltage	RGB24VDC	Parallel	1.1M 4X24AWG Cable	1W	N/A	D35X28	D26

\*IES Data support.

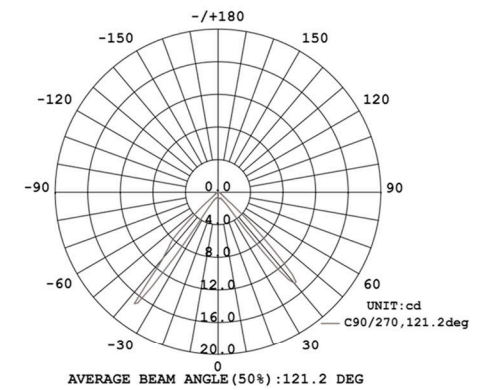
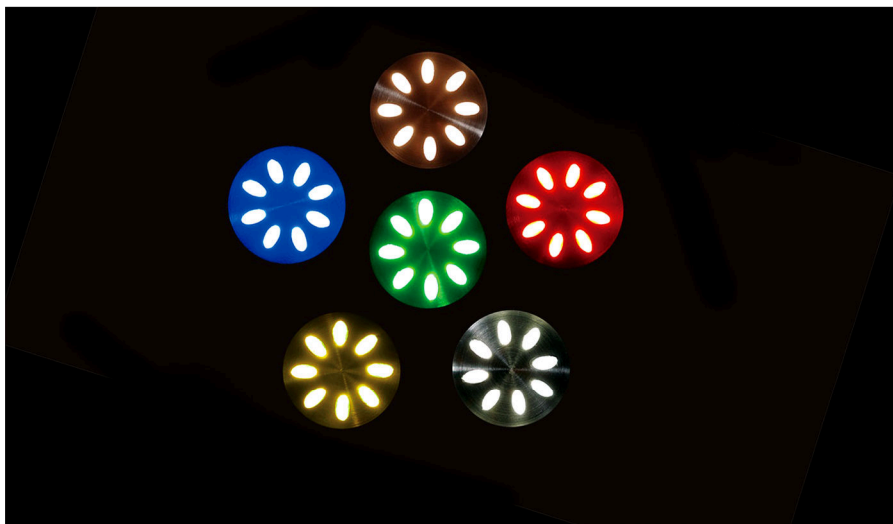

LED Colours



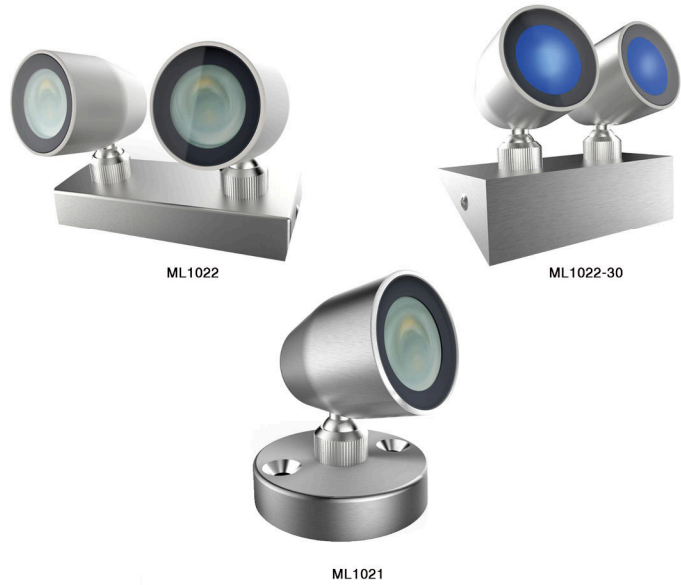

■ ML102

Miniature display light featuring Stainless Steel construction rated to IP65 making this product suitable for both interior and exterior applications. The product is directional and thus perfect for lighting focal features on the wall or within display cabinets. Tempered glass. Incorporates an integrated CREE USA LED white chip set powered at 1W or 2W. A low energy, no maintenance solution

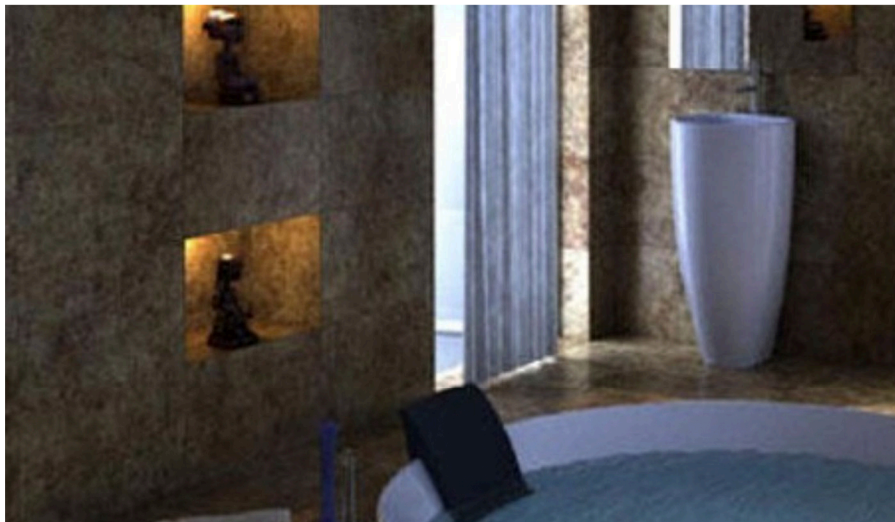

DESCRIPTION

LED Light source	High Power LED
Light Color	CW,WW,NW,Red,Green,Blue,Amber
Material	SUS316
Optics	S20° / F60°
Power	1W/2W
Power supply	N/A
Dimension	N/A
Weight	N/A
IP Rating	IP65
Approvals	CE,RoHS,IP
Ambient temperature	-20°C ~ +45°C
Average life	50,000Hrs
Accessories(Optional)	N/A
Applications	Indoor/Outdoor/Landscape

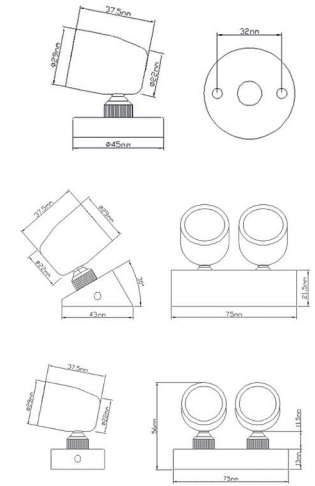

Model No.	LED Brand	Color	Beam	PowerMode	Input	Wiring	Cable	Power	Luminous Flux	Dimension	DrillSize
ML1021	CREE	CW,WW, NW,Red Green,Blue,Amber	S20/F60	Constant current	350mA	Series	1W 1.1M 2X24AWG Cable	100LM	D45X53	N/A	
ML1022	CREE	CW,WW, NW,Red Green,Blue,Amber	S20/F60	Constant current	350mA	Series	2W 1.1M 2X24AWG Cable	200LM	35X75X56	N/A	
ML1022-30	CREE	CW,WW, NW,Red Green,Blue,Amber	S20/F60	Constant current	350mA	Series	2W 1.1M 2X24AWG Cable	200LM	43X75X56	N/A	

\*IES Data support.

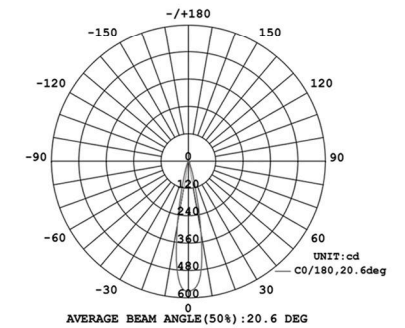
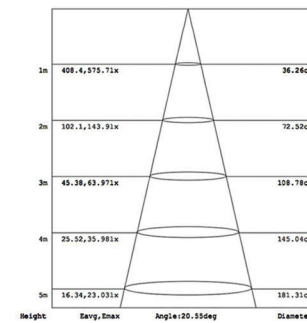

LED Colours

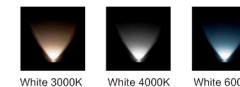



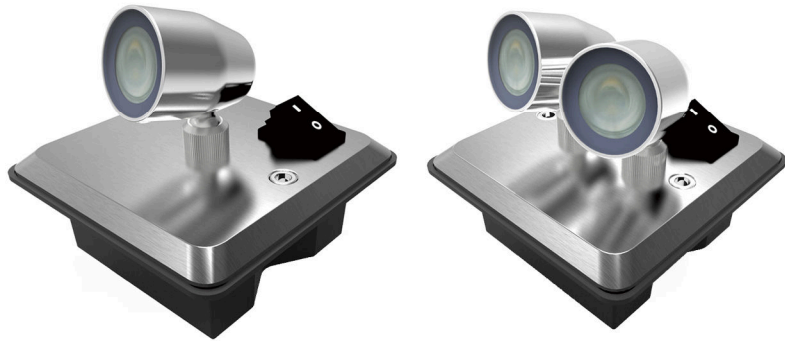

ML102-L

ML102-2L

■ ML102-L

Mini wall lights are stylish and functional. Great for lighting pictures and focal items, as well as using for reading or simply adding style to walls, wooden beams and ceilings. Tempered glass. Made from marine grade stainless and IP rated to 40 allows for installation both indoor. You can chose from 6 ambient LED colors and 3 wall mounting brackets to suit any lighting scheme.

DESCRIPTION

LED Light source	High Power LED
Light Color	CW,WW,NW,Red,Green,Blue,Amber
Material	SUS316
Optics	S20° / F60°
Power	1W/2W
Power supply	N/A
Dimention	N/A
Weight	N/A
IP Rating	IP40
Approvals	CE,RoHS
Accessories(Optional)	N/A
Applications	Indoor

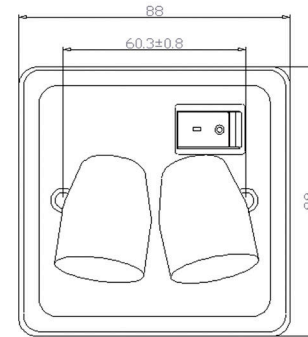

MODEL NO.	LED Brand	Color	BEAM	PowerMode	Input	Wiring	Power	Luminous	Dimention	DrillSize
ML102-L	CREE	CW,WW, NW,Red Green,Blue,Amber	S20/F60	Constant voltage	100-240VAC	Parallel	1W	100LM	88X88X80	N/A
ML102-2L	CREE	CW,WW, NW,Red Green,Blue,Amber	S20/F60	Constant voltage	100-240VAC	Parallel	2W	200LM	88X88X80	N/A

\*IES Data support.

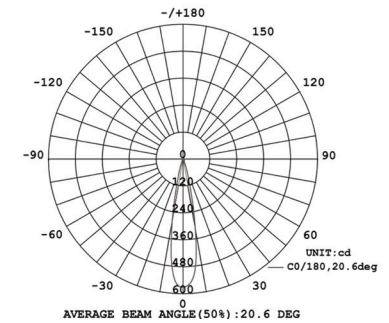
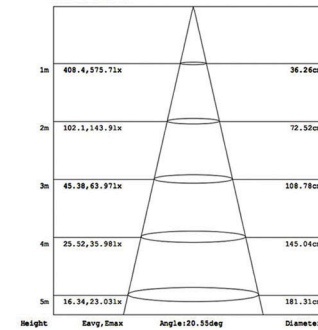

LED Colours

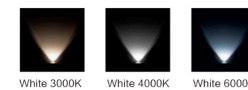

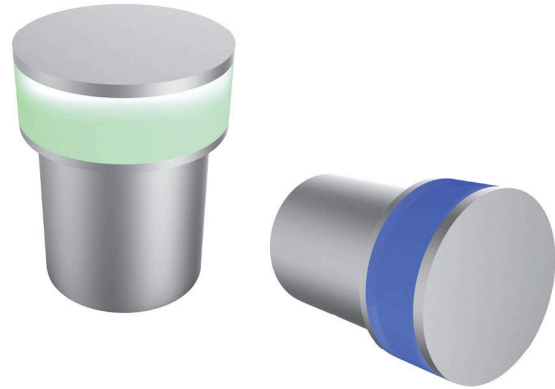

■ ML103

Add impact to any area with the ML103 wall light. An elegant 'halo' effect is created around the unit in a choice of 7 ambient LED colors. Tempered glass. Finished to a high standard using anodized aluminum, this trendy mini-light will look great in superior establishments and homes.

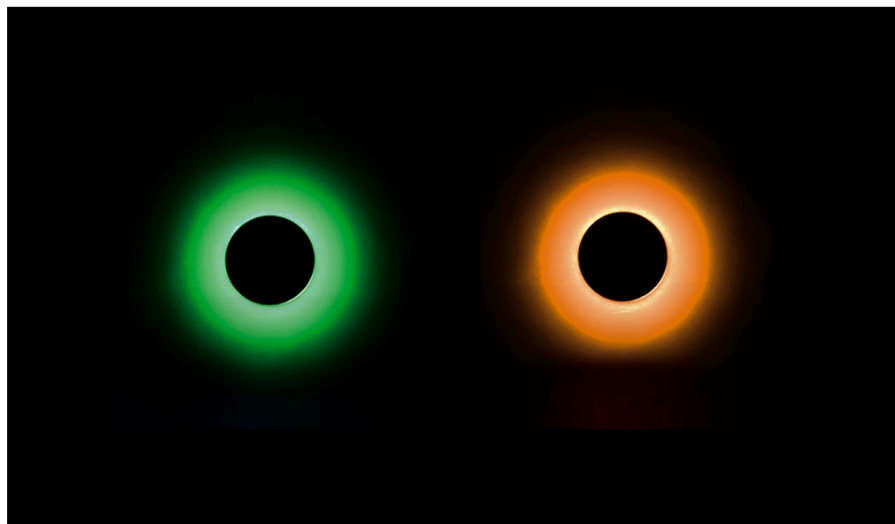

DESCRIPTION

LED Light source	High Power LED
Light Color	RGB,CW,WW,NW,Red,Green,Blue,Amber
Material	Aluminum
Optics	N/A
Power	1W
Power supply	N/A
Dimension	D32X44
Weight	56g
IP Rating	IP65
Approvals	CE,RoHS,IP
Ambient temperature	-20°C ~ +45°C
Average life	50,000Hrs
Accessories(Optional)	N/A
Applications	Indoor/Outdoor

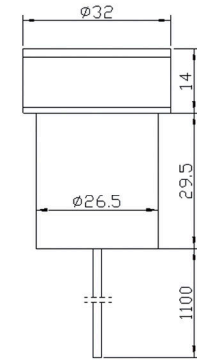

Model No.	LED Brand	Color	Beam	PowerMode	Input	Wiring	Cable	Power	Luminous Flux	Dimension	DrillSize
ML103	CREE	CW,WW, NW,Red Green,Blue,Amber	N/A	Constant current	350mA	Series	1.1M 2X0.4mm <sup>2</sup>	1W	N/A	D32X44	D27
ML103D	CREE	CW,WW, NW,Red Green,Blue,Amber	N/A	Constant voltage	24VDC	Parallel	1.1M 2X0.4mm <sup>2</sup> Cable	1.3W	N/A	D32X44	D27
ML103RGB	Edison	RGB	N/A	Constant voltage	RGB24VDC	Parallel	1.1M 4X24AWG Cable	1W	N/A	D32X44	D27

\*IES Data support.

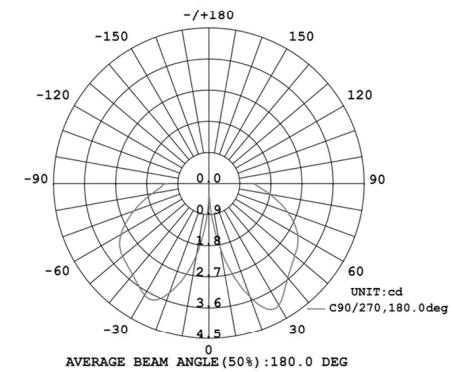

LED Colours

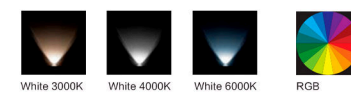



■ ML104

Contemporary, chic, yet rugged, the ML104 decorative mini-light adds style to floors, bars, walls and stairs. Tempered glass. Made from marine grade stainless steel and IP rated to 68 ensures you can use this product indoors or out.

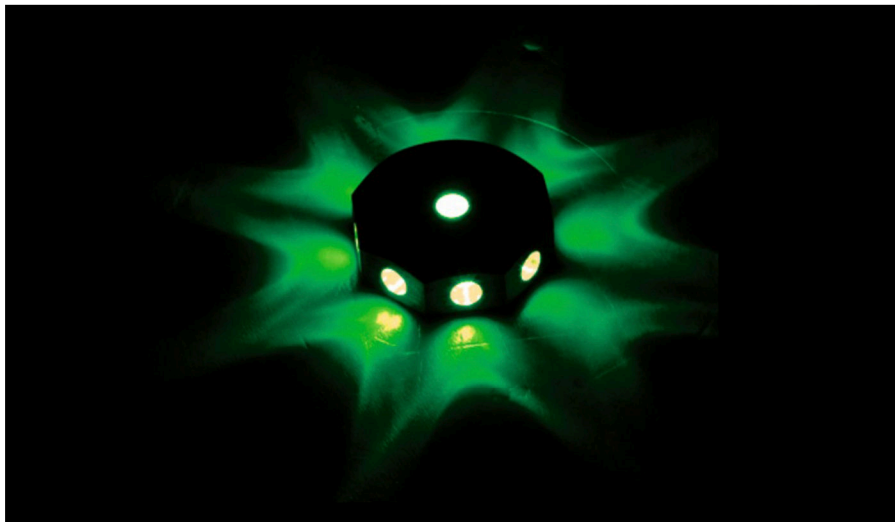

DESCRIPTION

LED Light source	High Power LED
Light Color	RGB,CW,WW,NW,Red,Green,Blue,Amber
Material	SUS316
Optics	N/A
Power	1W
Power supply	N/A
Dimension	38X38X30
Weight	110g
IP Rating	IP68
Approvals	CE,RoHS,IP
Ambient temperature	-20°C ~ +45°C
Average life	50,000Hrs
Accessories(Optional)	N/A
Applications	Indoor/Outdoor/Landscape/Submersible

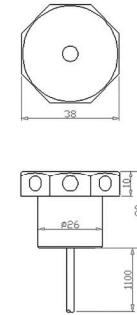

Model No.	LED Brand	Color	Beam	PowerMode	Input	Wiring	Cable	Power	Luminous Flux	Dimension	DrillSize
ML104	CREE	CW,WW, NW,Red Green,Blue,Amber	N/A	Constant current	350mA	Series	1.1M 2X0.4mm <sup>2</sup> Cable	1W	N/A	38X38X30	D27
ML104D	CREE	CW,WW, NW,Red Green,Blue,Amber	N/A	Constant voltage	24VDC	Parallel	1.1M 2X0.4mm <sup>2</sup> Cable	1.2W	N/A	38X38X30	D27
ML104RGB	Edison	RGB	N/A	Constant voltage	RGB24VDC	Parallel	1.1M 4X24AWG Cable	1W	N/A	38X38X30	D27

\*IES Data support.

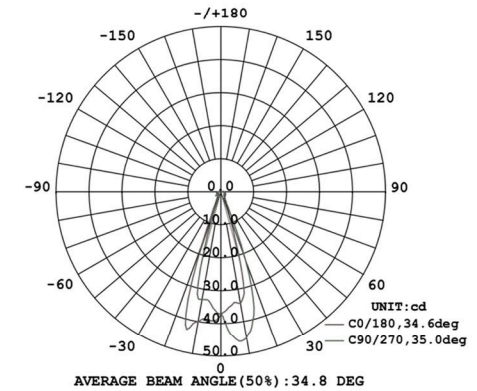

LED Colours





DESCRIPTION

LED Light source	High Power LED
Light Color	CW,WW,NW,Red,Green,Blue,Amber
Material	Aluminum
Optics	S20° / F60°
Power	1X3W
Power supply	N/A
Dimension	D45X70
Weight	N/A
IP Rating	IP65
Approvals	CE,RoHS,IP
Accessories(Optional)	N/A
Applications	Indoor/Outdoor

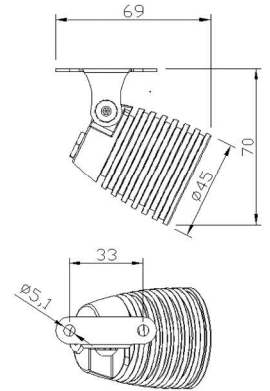

■ ML105

Tempered glass. This anodized aluminum version of our ML105 provides a sleeker, less obtrusive presence in your garden. It gives you the choice of LED colors, wide or narrow beam angles and ±100° tilting head.

Model No.	LED Brand	Color	Beam	PowerMode	Input	Wiring	Cable	Power	Luminous Flux	Dimension	DrillSize
ML105	CREE	CW,WW, NW,Red,Green,Blue,Amber	S20/F60	Constant current	700mA	Series	1.1M 2X0.4mm <sup>2</sup> Cable	1X3W	N/A	D45X70	N/A
ML105D	CREE	CW,WW, NW,Red,Green,Blue,Amber	S20/F60	Constant voltage	24VDC	Parallel	1.1M 2X0.4mm <sup>2</sup> Cable	1X3W	N/A	D45X70	N/A

\*IES Data support.

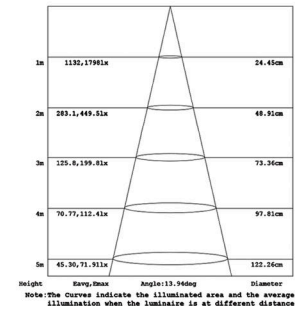
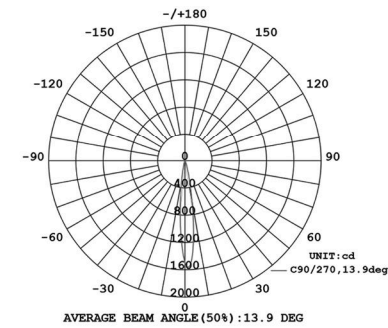
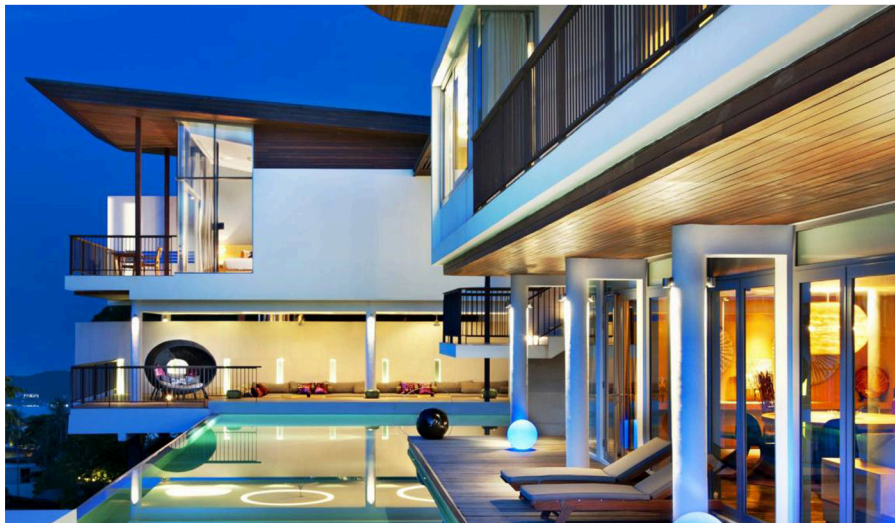

LED Colours

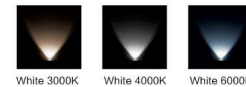



ML110

ML220

■ ML110

Stylish, functional and finished to the highest standards in aluminum, this item creates stunning effects on walls in both residential and commercial environments. Using a spot lens keeps the light narrow and direct, sending light over long distances. By using the provided wall plug, installation will be quick and easy, this will also give you the option of adjusting the direction of the light by simply turning the product whilst in the wall. Tempered glass.

DESCRIPTION

LED Light source	High Power LED
Light Color	CW,WW,NW,Red,Green,Blue,Amber
Material	Aluminum
Optics	S20° / F60°
Power	1W / 2W
Power supply	N/A
Dimension	N/A
Weight	100g/160g
IP Rating	IP65
Approvals	CE,RoHS,IP
Ambient temperature	-20°C ~ +45°C
Average life	50,000Hrs
Accessories(Optional)	
Applications	Indoor/Outdoor/Landscape

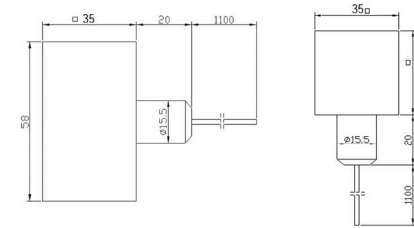

Model No.	LED Brand	Color	Beam	PowerMode	Input	Wiring	Cable	Power	Luminous Flux	Dimension	DrillSize
ML110	CREE	CW,WW, NW,Red Green,Blue,Amber	S20/F60	Constant current	350mA	Series	1.1M 2X0.4mm <sup>2</sup> Cable	1W	100LM	35x35x55	D20
ML220	CREE	CW,WW, NW,Red Green,Blue,Amber	S20/F60	Constant current	350mA	Series	1.1M 2X0.4mm <sup>2</sup> Cable	2W	200LM	35x58x55	D20

\*IES Data support.

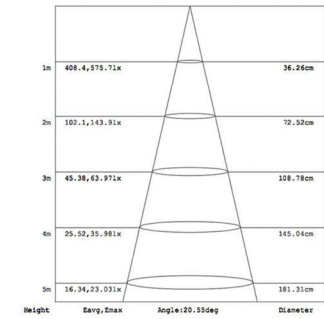
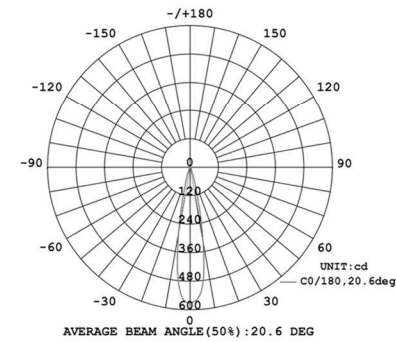
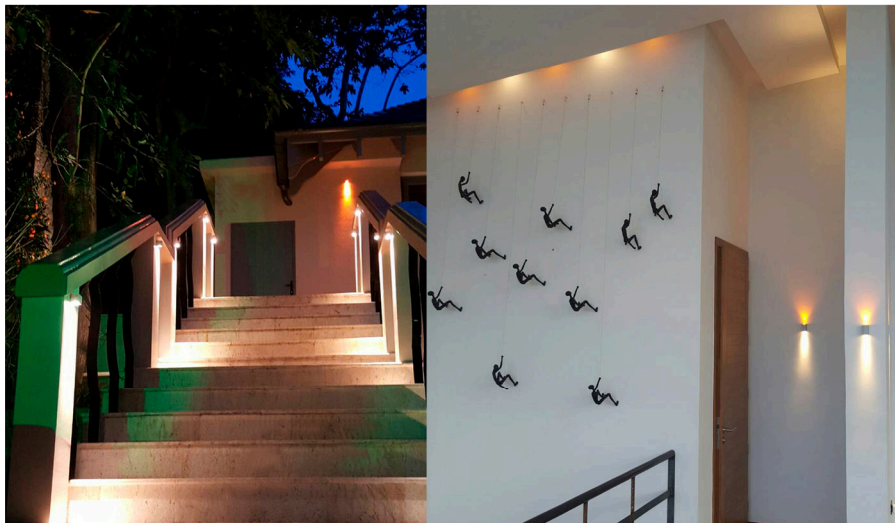

LED Colours

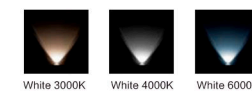



DESCRIPTION

<b>LED LIGHT SOURCE</b>	High Power LED
<b>LIGHT COLOR</b>	CW,WW,NW,Red,Green,Blue,Amber
<b>MATERIAL</b>	Aluminum
<b>OPTICS</b>	S20° / F60°
<b>POWER</b>	1W
<b>POWER SUPPLY</b>	N/A
<b>DIMENSION</b>	N/A
<b>WEIGHT</b>	N/A
<b>IP RATING</b>	IP40
<b>APPROVALS</b>	CE,RoHS
<b>ACCESSORIES(OPTIONAL)</b>	N/A

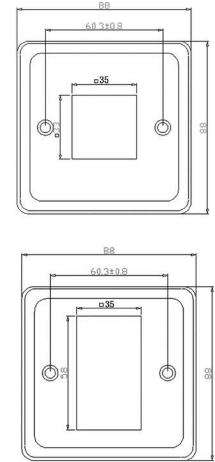

■ ML110-L

Stylish, functional and finished to the highest standards in aluminum, it creates stunning effects on walls in both residential and commercial environments. Using a spot lens keeps the light narrow and direct, sending light over long distances. Complete with an integral power supply, wall fixings and pattress box, making installation quick and easy Tempered glass.

MODEL NO.	LED Brand	Color	BEAM	PowerMode	Input	Wiring	Power	Luminous Flux	Dimension	DrillSize
ML110-L	CREE	CW,WW, NW,Red Green,Blue,Amber	S20/F60	Constant voltage	100-240VAC	Parallel	1W	100LM	88x88x80	N/A
ML220-L	CREE	CW,WW, NW,Red Green,Blue,Amber	S20/F60	Constant voltage	100-240VAC	Parallel	2W	200LM	88x88x80	N/A

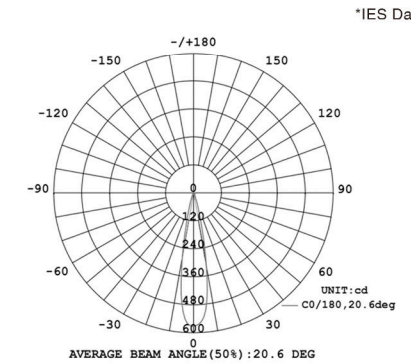
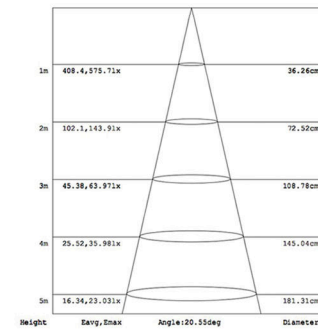

\*IES Data support.

LED Colours

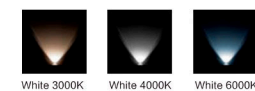



# SPIKE LIGHT

SPECIALIZED MANUFACTURER  
LED LIGHTING PRODUCTS



DESCRIPTION

<b>LED Light source</b>	COB LED
<b>Light Color</b>	CW,WW,NW
<b>Material</b>	Aluminum
<b>Optics</b>	S24° / 40° / F60°
<b>Power</b>	16W
<b>Power supply</b>	24VDC
<b>Dimension</b>	D100X277
<b>Weight</b>	750g
<b>IP Rating</b>	IP65
<b>Approvals</b>	CE,RoHS,IP
<b>Ambient temperature</b>	-20°C ~ +45°C
<b>Average life</b>	50,000Hrs
<b>Accessories(Optional)</b>	N/A
<b>Applications</b>	Indoor/Outdoor/Landscape

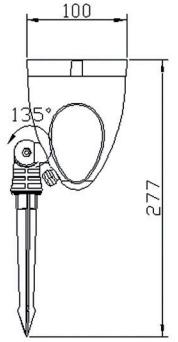

■ SL100

This black anodized aluminum version of our SL100 spike light provides less obtrusive presence in your garden. Tempered glass. It gives you the choice of LED colors, wide or narrow beam angles and 135° tilting head.

Model No.	LED Brand	Color	Beam	PowerMode	Input	Wiring	Cable	Power	Luminous Flux	Dimension	DrillSize
SL100	CREE	WW3000K	S24/40/F60	Constant voltage	24VDC	Parallel	1.1M 2X0.75mm <sup>2</sup> Cable	16W	1600LM	D100X277	N/A
SL100	CREE	NW4200K	S24/40/F60	Constant voltage	24VDC	Parallel	1.1M 2X0.75mm <sup>2</sup> Cable	16W	1600LM	D100X277	N/A
SL100	CREE	CW5000K	S24/40/F60	Constant voltage	24VDC	Parallel	1.1M 2X0.75mm <sup>2</sup> Cable	16W	1760LM	D100X277	N/A

\*IES Data support.

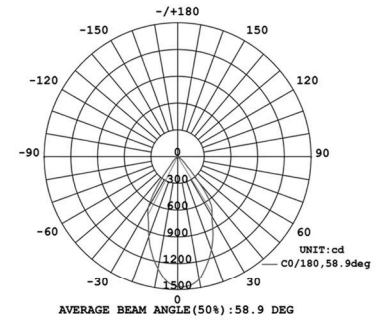
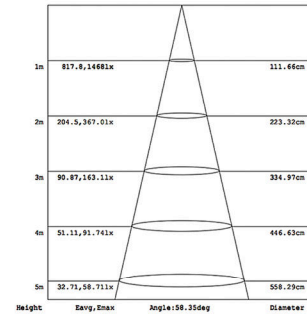

LED Colours

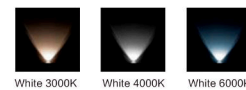





■ SL131

Marine grade 316 stainless steel in-ground spike fixture complete with integral CREE LED package. Tempered glass. 12/45 degree beam options. No mechanical joints to light source ensures robust protection against water ingress. Product runs cool meeting all touch temperature requirements.

DESCRIPTION

LED Light source	High Power LED
Light Color	CW,WW,NW,Red,Green,Blue,Amber
Material	SUS316
Optics	S12° / F45°
Power	1W
Power supply	N/A
Dimension	D42X420
Weight	630g
IP Rating	IP65
Approvals	CE,RoHS,IP
Ambient temperature	-20°C ~ +45°C
Average life	50,000Hrs
Accessories(Optional)	N/A
Applications	Indoor/Outdoor/Landscape

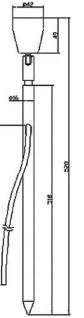

Model No.	LED Brand	Color	Beam	PowerMode	Input	Wiring	Cable	Power	Luminous Flux	Dimension	DrillSize
SL131	CREE	CW,WW, NW,Red Green,Blue,Amber	S12/F45	Constant current	350mA	Series	3M 2X0.75mm <sup>2</sup> Cable	1W	100LM	D42X420	N/A
SL131D	CREE	CW,WW, NW,Red Green,Blue,Amber	S12/F45	Constant voltage	24VDC	Parallel	3M 2X0.75mm <sup>2</sup>	1.3W	100LM	D42X420	N/A

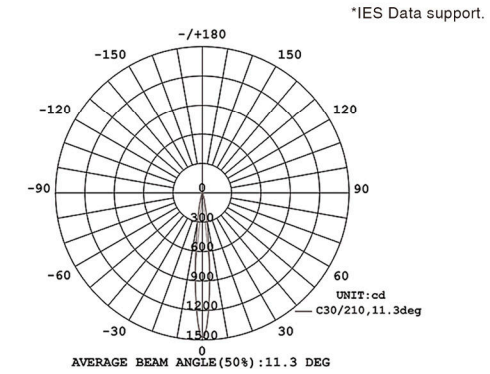
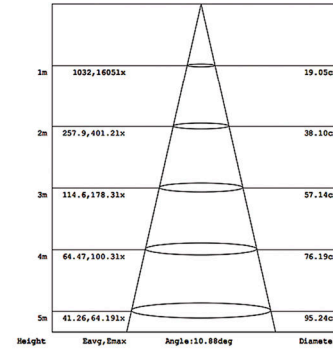
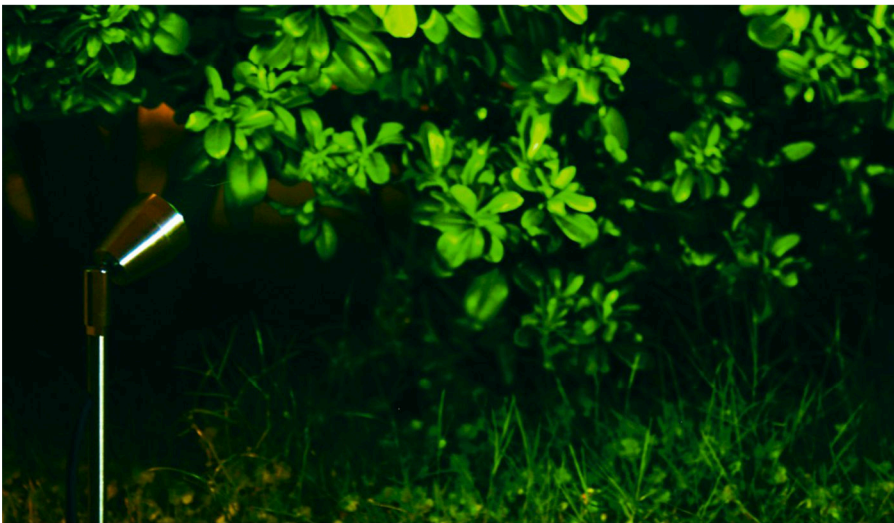

\*IES Data support.



LED Colours

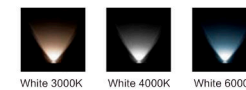



DESCRIPTION

<b>LED Light source</b>	High Power LED
<b>Light Color</b>	CW,WW,NW,Red,Green,Blue,Amber
<b>Material</b>	SUS316
<b>Optics</b>	S20° / F60°
<b>Power</b>	3W
<b>Power supply</b>	N/A
<b>Dimension</b>	D66X465
<b>Weight</b>	925g
<b>IP Rating</b>	IP65
<b>Approvals</b>	CE,RoHS,IP
<b>Ambient temperature</b>	-20°C ~ +45°C
<b>Average life</b>	50,000Hrs
<b>Accessories(Optional)</b>	N/A
<b>Applications</b>	Indoor/Outdoor/Landscape

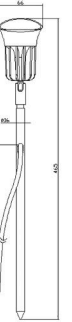

■ SL133

Marine grade 316 stainless steel in-ground spike fixture complete with integral CREE LED package. Tempered glass. 20/60 degree beam options. No mechanical joints to light source ensures robust protection against water ingress. Product runs cool meeting all touch temperature requirements.

Model No.	LED Brand	Color	Beam	PowerMode	Input	Wiring	Cable	Power	Luminous Flux	Dimension	DrillSize
SL133	CREE	CW,WW, NW,Red,Green,Blue,Amber	S20/F60	Constant current	350mA	Series	3M 2X0.75mm <sup>2</sup> Cable	3W	300LM	D66X465	N/A
SL133D	CREE	CW,WW, NW,Red,Green,Blue,Amber	S20/F60	Constant voltage	12/24VDC	Parallel	3M 2X0.75mm <sup>2</sup> Cable	3.5W	300LM	D66X465	N/A

\*IES Data support.

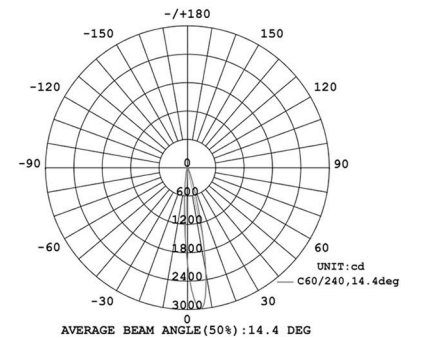
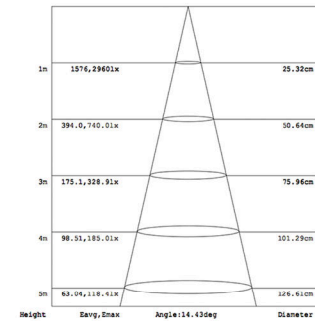

LED Colours

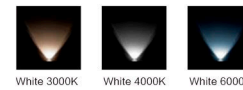



# QUICK INSTALL LIGHT



# GL116D-LS GROUND LIGHT



### LED Colours

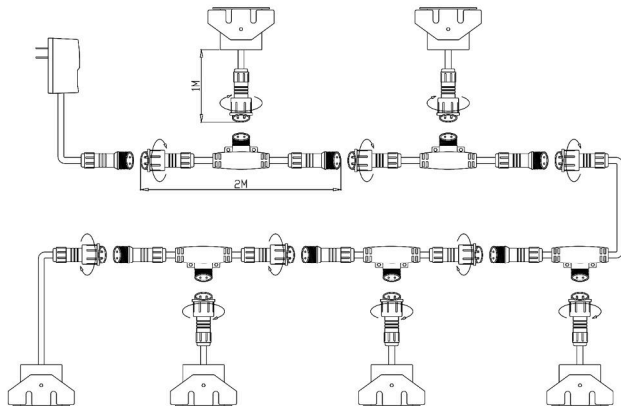

## DESCRIPTION

<b>LED LIGHT SOURCE</b>	High Power LED
<b>LIGHT COLOR</b>	CW,WW,NW,Amber,Red,Green,Blue
<b>MATERIAL</b>	SUS316
<b>OPTICS</b>	See attached sheet
<b>POWER</b>	See attached sheet
<b>POWER INPUT</b>	24VDC
<b>DIMENSION</b>	See attached sheet
<b>WEIGHT</b>	N/A
<b>IP RATING</b>	IP65
<b>APPROVALS</b>	CE,RoHS
<b>ACCESSORIES</b>	Constant voltage Driver
<b>APPLICATIONS</b>	Courtyards, corridors, squares, etc.

Model No.	LED Brand	Color	Beam	PowerMode	Input	Wiring	Cable	Power	Luminous Flux	Dimension	DrillSize
GL116D-LS	CREE	CW,WW, NW,Red Green,Blue,Amber	S12/F45	Constant voltage	24VDC	Parallel	2X0.75mm <sup>2</sup> Plug	6x1.3W	600LM	D60XH45	D50
GL140D-LS	CREE	CW,WW, NW,Red Green,Blue,Amber	S20/F60	Constant voltage	24VDC	Parallel	2X0.75mm <sup>2</sup> Plug	6x3.5W	1800LM	D76XH47	D65
GL166D-LS	CREE	CW,WW, NW,Red Green,Blue,Amber	S10/F40	Constant voltage	24VDC	Parallel	2X0.75mm <sup>2</sup> Plug	6x6.5W	3600LM	D96XH47	D85
GL168D-LS	CREE	CW,WW, NW,Red Green,Blue,Amber	S10/F40	Constant voltage	24VDC	Parallel	2X0.75mm <sup>2</sup> Plug	6x9W	4800LM	D96XH47	D85

\*IES Data support.

# GL116DMX-LS GROUND LIGHT



## LED Colours

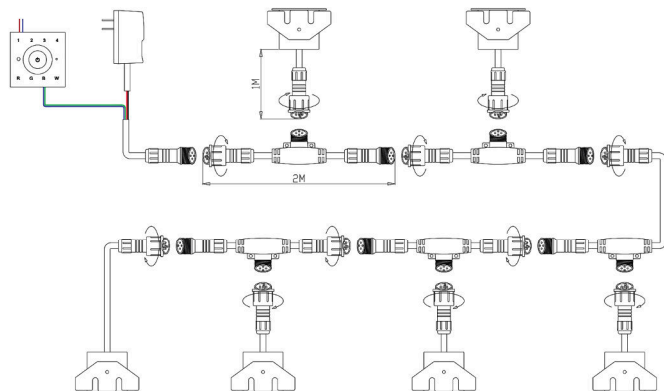
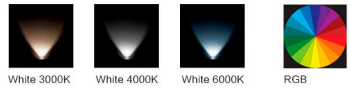

## DESCRIPTION

<b>LED LIGHT SOURCE</b>	High Power LED
<b>LIGHT COLOR</b>	RGB,CW,WW,NW,Amber,Red,Green,Blue
<b>MATERIAL</b>	SUS316
<b>OPTICS</b>	See attached sheet
<b>POWER</b>	See attached sheet
<b>POWER INPUT</b>	24VDC DMX Controller
<b>DIMENSION</b>	See attached sheet
<b>WEIGHT</b>	N/A
<b>IP RATING</b>	IP65
<b>APPROVALS</b>	CE,RoHS
<b>AMBIENT TEMPERATURE</b>	-20°C ~ +45°C
<b>AVERAGE LIFE</b>	50,000Hrs
<b>ACCESSORIES</b>	Constant voltage DMX Controller
<b>APPLICATIONS</b>	Courtyards, corridors, squares, etc

Model No.	LED Brand	Color	Beam	Power Mode	Input	Wiring	Cable	Power Flux	Luminous	Dimension
GL116DMX-LS	CREE	RGB,CW,WW,NW, Amber,Red,Green,Blue	S12/F45	Constant voltage	24VDC DMX Controller	Parallel	4X0.5mm <sup>2</sup> Plug	6x1.5W	N/A	D60XH45 D50
GL140DMX-LS	CREE	RGB,CW,WW,NW, Amber,Red,Green,Blue	S20/F60	Constant voltage	24VDC DMX Controller	Parallel	4X0.5mm <sup>2</sup> Plug	6x3.5W	N/A	D76XH47 D65
GL166DMX-LS	CREE	RGB,CW,WW,NW, Amber,Red,Green,Blue	S10/F40	Constant voltage	24VDC DMX Controller	Parallel	4X0.5mm <sup>2</sup> Plug	6x6.5W	N/A	D96XH47 D85
GL168DMX-LS	CREE	RGB,CW,WW,NW, Amber,Red,Green,Blue	S10/F40	Constant voltage	24VDC DMX Controller	Parallel	4X0.5mm <sup>2</sup> Plug	6x9W	N/A	D96XH47 D85

DMX decoder in built

\*IES Data support.

# GL118RGB-LS GROUND LIGHT



LED Colours



RGB

Input:100-240AC  
Output:24VDC



RF remote

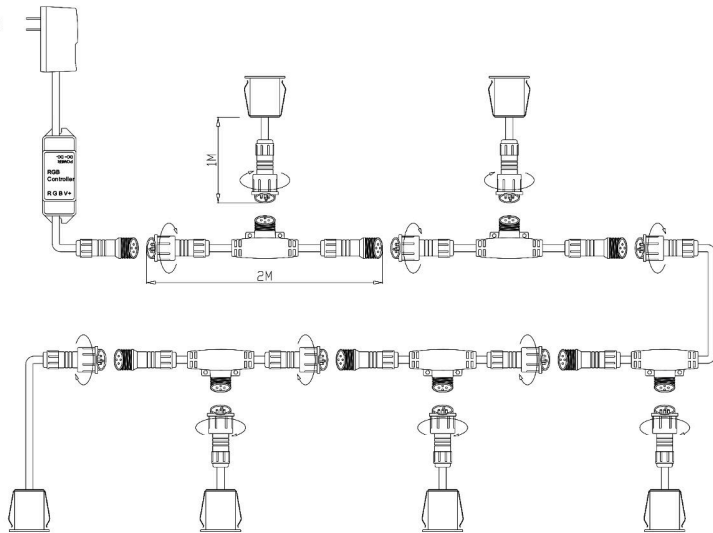

## DESCRIPTION

LIGHT SOURCE	High Power LED
LIGHT COLOR	RGB
MATERIAL	SUS316
OPTICS	120°
POWER	See attached sheet
POWER INPUT	24VDC RGB Controller
DIMENSION	See attached sheet
WEIGHT	N/A
IP RATING	IP65
APPROVALS	CE,RoHS
AMBIENT TEMPERATURE	-20°C ~ +45°C
AVERAGE LIFE	50,000Hrs
ACCESSORIES	Constant voltage RGB Controller
APPLICATIONS	Courtyards, corridors, squares, etc

Model No.	LED Brand	Color	Beam	PowerMode	Input	Wiring	Cable	Power	Luminous Flux	Dimention	DrillSize
GL118RGB-LS	Edison	RGB	120	Constant voltage	24VDC RGB Controller	Parallel	4X0.5mm2 Plug	6X1W	N/A	D36.3XH37	D29
GL550RGB-LS	Edison	RGB	120	Constant voltage	24VDC RGB Controller	Parallel	4X0.5mm2 Plug	6X3W	N/A	D76XH47	D65

\*IES Data support.

# ACCESSORIES

SPECIALIZED MANUFACTURER  
LED LIGHTING PRODUCTS



## PRODUCT FITTING ACCESSORIES

### INSTALLATION SLEEVE FOR LAMP DESCRIPTION

Material: Aluminium

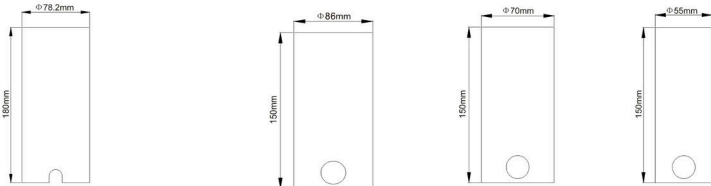

TS130

TS166

TS140

TS116

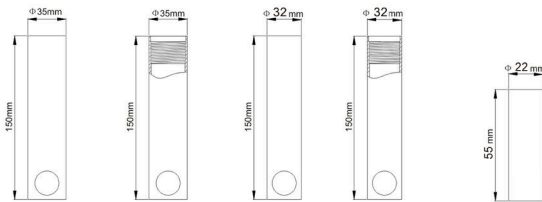

TS119

TS119T

TS118

TS118T

TS112

## PRODUCT FITTING ACCESSORIES

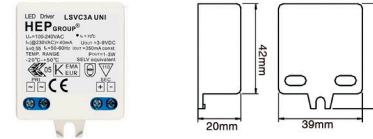

Model: LSV3A  
 LED Type: High Power LED 1W x 1 to 3  
 Supply Voltage: 100~240V AC  
 Supply Current (@230V AC) : 40mA  
 Frequency: 50/60Hz  
 Power Factor: 0.55  
 Constant Output Current: 350mA  
 Rated Output Power: 1~3W  
 Rated Output Voltage: 3~9V DC  
 Temp Range: -20°C ~ +50°C  
 Tc = 70°C  
 Size: 39 x 42 x 20mm  
 Weight: 30g  
 Approbations:

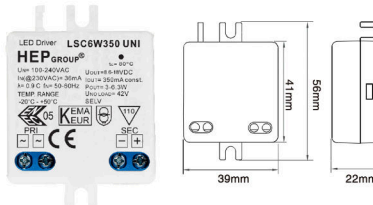

Model: LSC6W350  
 LED Type: High Power LED 1W x 3 to 6  
 Supply Voltage: 100 ~ 240V AC  
 Supply Current: 36mA  
 Frequency: 50/60Hz  
 Power Factor: 0.9  
 Constant Output Current: 350mA  
 Rated Output Power: 3~6W  
 Rated Output Voltage: 8.6~18V DC  
 Temp Range: -20°C ~ +50°C  
 Tc = 80°C  
 Size: 55.5 x 38.5 x 22mm  
 Weight: g  
 Approbations:

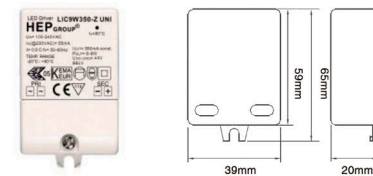

Model: LIC9W350-Z  
 LED Type: High Power LED 1W x 6 to 9  
 Supply Voltage: 100 ~ 240V AC  
 Supply Current: 130mA Max.  
 Frequency: 50/60Hz  
 Power Factor: 0.9  
 Constant Output Current: 350mA  
 Rated Output Power: 6~ 9W  
 Rated Output Voltage: 17.1~25.7V DC  
 Temp Range: -20°C ~ +50°C  
 Tc = 80°C  
 Size: 65 x 39 x 20mm  
 Weight: 48g  
 Approbations:

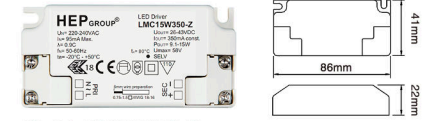

Model: LMC15W350-Z  
 LED Type: High Power LED 1W x 10 to 15  
 Supply Voltage: 220~240V AC  
 Supply Current: 95mA Max.  
 Frequency: 50/60Hz  
 Power Factor: 0.9  
 Constant Output Current: 350mA  
 Rated Output Power: 9.1~15W  
 Rated Output Voltage: 26~43V DC  
 Temp Range: -20°C ~ +50°C  
 Tc = 80°C  
 Size: 85 x 41 x 22mm  
 Weight: 55 g  
 Approbations:



Model: LBC20W350-Z  
 LED Type: High Power LED 1W x 13 to 20  
 Supply Voltage: 100-240V AC  
 Supply Current: 245mA Max.  
 Frequency: 50/60Hz  
 Power Factor: 0.9  
 Constant Output Current: 350mA  
 Rated Output Power: 13~20W  
 Rated Output Voltage: 35~ 58V DC  
 Temp Range: -20°C ~ +50°C  
 Tc = 85°C  
 Size: 117 x 44 x 30mm  
 Weight: 86g  
 Approbations:



Model: APC-35-350  
 LED Type: High Power LED 1W x 10 to 35  
 Supply Voltage: 100-240V AC  
 Supply Current: 500mA Max.  
 Frequency: 50/60Hz  
 Power Factor: 0.84  
 Constant Output Current: 350mA  
 Rated Output Power: 10~ 35W  
 Rated Output Voltage: 28~ 100V DC  
 Temp Range: -30°C ~ +70°C  
 Tc = 80°C  
 Size: 84 x 57 x 29.5mm  
 Weight: 150g  
 Approbations:



PRODUCT FITTING ACCESSORIES

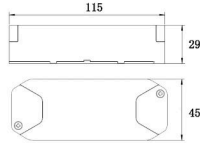

Model: CertaDrive 15W 0.35A 42V  
 LED Type: High Power LED 15W  
 Supply Voltage: 220~240V AC  
 Supply Current: 0.08A  
 Frequency: 50/60Hz  
 Power Factor:  $\geq 0.9$   
 Constant Output Current: 350mA  
 Rated Output Power: 11~15W  
 Rated Output Voltage: 32~42V DC  
 Temp Range: 0°C ~ +50°C  
 Tc = 75°C  
 Size: 115 x 45 x 29mm  
 Approbations:

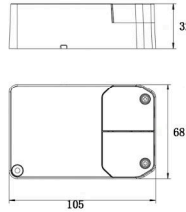

Model: CertaDrive 25W 0.6A 42V  
 LED Type: High Power LED 25W  
 Supply Voltage: 220~240V AC  
 Supply Current: 0.14A  
 Frequency: 50/60Hz  
 Power Factor:  $\geq 0.9$   
 Constant Output Current: 600mA  
 Rated Output Power: 20~25W  
 Rated Output Voltage: 32~42V DC  
 Temp Range: 0°C ~ +50°C  
 Tc = 75°C  
 Size: 105 x 68 x 32mm  
 Approbations:

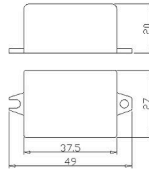

Model: EVOS7W350  
 LED Type: High Power LED 1W x 1 to 6  
 Supply Voltage: 200~240V AC  
 Supply Current: 80mA  
 Frequency: 50/60Hz  
 Power Factor: 0.5  
 Constant Output Current: 350mA  
 Rated Output Power: 1~6.7W  
 Rated Output Voltage: 2.7~19.2V DC  
 Temp Range: -20°C ~ +50°C  
 Tc = 80°C  
 Size: 49 x 27 x 20mm



Model NO.	Output Voltage	Output Current	Output Watts
DE-60-06W	6VAC	10A	60W
DE-60-7.5W	7.5VAC	8A	60W
DE-60-09W	9VAC	6.67A	60W
DE-60-12W	12VAC	5A	60W
DE-60-15W	15VAC	4A	60W
DE-60-18W	18VAC	3.33A	60W
DE-60-20W	20VAC	3A	60W
DE-60-22W	22VAC	2.73A	60W
DE-60-24W	24VAC	2.5A	60W
DE-20-12W	12VAC	1.67A	20W

Input: 230/240VAC 50Hz  
 Standard: EN61558-1 EN61558-2-6  
 Approval: EUROPE, UK, SAA  
 Size: 102x64x74mm  
 Weight: 1450g

PRODUCT FITTING ACCESSORIES



Name: Junction Box  
 Model: EIP68-1A EIP68-1B EIP68-1C  
 Colour: Black  
 IP Rating: IP68  
 Waterproof depth: 4M  
 Weight: 45g  
 Approbations: ROHS

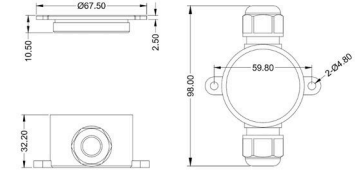

規格 PART NUMBER	進線 $\phi$ mm IN CABLE	出線 $\phi$ mm OUT CABLE	内部尺寸 mm INSIDE DIMENSION
EIP68-1A	1X $\phi$ 7-10.5	1X $\phi$ 7-10.5	$\phi$ 45X30mm
EIP68-1B	1X $\phi$ 5.0-8.0	1X $\phi$ 5.0-8.0	
EIP68-1C	1X $\phi$ 7.0-10.5	1X $\phi$ 5.0-8.0	



Name: Junction Box  
 Model: EIP68-2A EIP68-2B EIP68-2C  
 Colour: Black  
 IP Rating: IP68  
 Waterproof depth: 4M  
 Weight: 53g  
 Approbations: ROHS

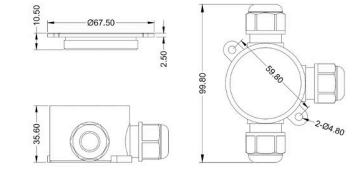

規格 PART NUMBER	進線 $\phi$ mm IN CABLE	出線 $\phi$ mm OUT CABLE	内部尺寸 mm INSIDE DIMENSION
EIP68-2A	2X $\phi$ 7.0-10.5	1X $\phi$ 7-10.5	$\phi$ 45X33.5mm
EIP68-2B	2X $\phi$ 7.0-10.5	1X $\phi$ 5.0-8.0	
EIP68-2C	2X $\phi$ 5.0-8.0	1X $\phi$ 5.0-8.0	



Name: Junction Box  
 Model: EIP68-3A EIP68-3B EIP68-3C EIP68-3D  
 Colour: Black  
 IP Rating: IP68  
 Waterproof depth: 4M  
 Weight: 65g  
 Approbations: ROHS

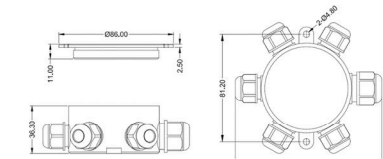

規格 PART NUMBER	進線 $\phi$ mm IN CABLE	出線 $\phi$ mm OUT CABLE	内部尺寸 mm INSIDE DIMENSION
EIP68-3A	1X $\phi$ 7.0-10.5	3X $\phi$ 5-7.9	$\phi$ 55X34mm
EIP68-3B	1X $\phi$ 7.0-10.5	3X $\phi$ 5-8.3	
EIP68-3C	1X $\phi$ 5.0-8.0	3X $\phi$ 5-7.9	
EIP68-3D	1X $\phi$ 5.0-8.0	3X $\phi$ 5-8.3	



Name: Junction Box  
 Model: EIP68-5A EIP68-5B EIP68-5C EIP68-5D  
 Colour: Black  
 IP Rating: IP68  
 Waterproof depth: 4M  
 Weight: 78g  
 Approbations: ROHS

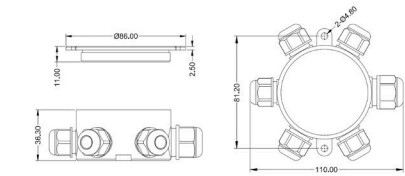

規格 PART NUMBER	進線 $\phi$ mm IN CABLE	出線 $\phi$ mm OUT CABLE	内部尺寸 mm INSIDE DIMENSION
EIP68-5A	1X $\phi$ 7.0-10.5	5X $\phi$ 5-7.9	$\phi$ 62.54X34mm
EIP68-5B	1X $\phi$ 7.0-10.5	5X $\phi$ 5.0-8.3	
EIP68-5C	1X $\phi$ 5.0-8.0	5X $\phi$ 5.0-7.9	
EIP68-5D	1X $\phi$ 5.0-8.0	5X $\phi$ 5.0-8.3	

**PRODUCT FITTING ACCESSORIES**



Name: Waterproof Connector  
 Model: KJ-PG9-07 KJ-PG9-05  
 Pole: 2  
 Rated Operation Voltage: 250V  
 Rated Current: 10A  
 Operation Temperature: -40 - 85°C  
 Colour: Black  
 IP Rating: IP68  
 Waterproof depth: 4M  
 Weight: 16.5g  
 Approbations: TUV SAA CE

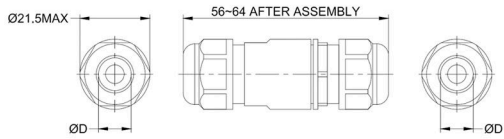

PART NUMBER	FOR CABLE DIAMETER D (MM)	PART 1	PART 2	TORQUE(Kgf.cm)	DAMAGE TORQUE(Kgf.cm)
KJ-PG9-07	5-7.9	PG9-08B	2 POLE TERMINAL	10.0-12.0	16.0
KJ-PG9-05	3-5.3	PG9-05B			



Name: Waterproof Connector  
 Model: KJ-PG9-08  
 Pole: 3  
 Rated Operation Voltage: 300V  
 Rated Current: 10A  
 Operation Temperature: -40 - 85°C  
 Colour: Black  
 IP Rating: IP68  
 Waterproof depth: 4M  
 Weight: 16.5g  
 Approbations: TUV SAA CE

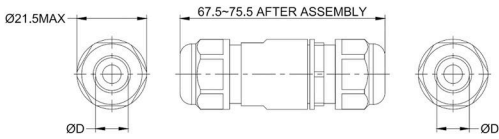

PART NUMBER	FOR CABLE DIAMETER D(MM)	PART 1	PART 2	TORQUE(Kgf.cm)	DAMAGE TORQUE(Kgf.cm)
KJ-PG9-08	4-8.2	KJ-PG9	3 POLE TERMINAL	10.0-12.0	16.0



Name: Waterproof Connector  
 Model: KJ-M20S-07 KJ-M20S-11 KJ4-M20S-0711 KJ4-M20S-07 KJ4-M20S-11  
 Pole: 3 or 4  
 Rated Operation Voltage: 400V  
 Rated Current: 13A  
 Operation Temperature: -40 - 95°C  
 Colour: Black  
 IP Rating: IP68  
 Waterproof depth: 4M  
 Weight: 30g  
 Approbations: TUV SAA CE

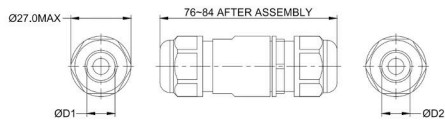

PART NUMBER	FOR CABLE ØD1(MM)	FOR CABLE ØD2(MM)	PART 1	PART 2	TORQUE(Kgf.cm)	DAMAGE TORQUE(Kgf.cm)
KJ-M20S-07	5-7.9	5-7.9	M20S-07	3 POLE TERMINAL	16.0-19.0	40.0
KJ-M20S-11	7-10.5	7-10.5	M20S-11			
KJ4-M20S-0711	5-7.9	7-10.5	M20S-11			
KJ4-M20S-07	5-7.9	5-7.9	M20S-07	4 POLE TERMINAL	16.0-19.0	40.0
KJ4-M20S-11	7-10.5	7-10.5	M20S-11			



Name: Waterproof Connector  
 Model: KJ-M25S-08 KJ-M25S-10 KJ-M25S-12 KJ-M25S-1214  
 Pole: 3 or 4  
 Rated Operation Voltage: 400V  
 Rated Current: 32A  
 Operation Temperature: -40 - 95°C  
 Colour: Black  
 IP Rating: IP68  
 Waterproof depth: 4M  
 Weight: 50g  
 Approbations: TUV SAA CE

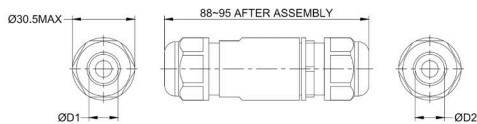

PART NUMBER	FOR CABLE ØD1(MM)	FOR CABLE ØD2(MM)	PART 1	PART 2	TORQUE(Kgf.cm)	DAMAGE TORQUE(Kgf.cm)
KJ-M25S-08	5-8.1	8-12	M25S-08	3 or 4 POLE TERMINAL	20-23 20-23	50 50
KJ-M25S-12	8-12	8-12	M25S-12			
KJ-M25S-14	10-14	10-14	M25S-14			
KJ-M25S-1214	10-14	8-12	M25S-12			



Name: Waterproof Connector  
 Model: KJ5-M25S-08 KJ5-M25S-10 KJ5-M25S-12 KJ5-M25S-1214  
 Pole: 5  
 Rated Operation Voltage: 500V  
 Rated Current: 13A  
 Operation Temperature: -40 - 95°C  
 Colour: Black  
 IP Rating: IP68  
 Waterproof depth: 4M  
 Weight: 50g  
 Approbations: TUV SAA CE

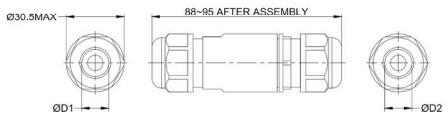

PART NUMBER	FOR CABLE ØD1(MM)	FOR CABLE ØD2(MM)	PART 1	PART 2	TORQUE(Kgf.cm)	DAMAGE TORQUE(Kgf.cm)
KJ5-M25S-08	8-8.1	8-12	M25S-08	5 POLE TERMINAL	20-23 20-23	50 50
KJ5-M25S-12	8-12	8-12	M25S-12			
KJ5-M25S-14	10-14	10-14	M25S-14			
KJ5-M25S-1214	10-14	8-12	M25S-12			

**PRODUCT FITTING ACCESSORIES**



Name: Waterproof Connector  
 Model: 3T-M20-0806H2 3T-M20-1006H2  
 Pole: 3  
 Rated Operation Voltage: 400V  
 Rated Current: 13A  
 Operation Temperature: -40 - 95°C  
 Colour: Black  
 IP Rating: IP68  
 Waterproof depth: 4M  
 Weight: 36g  
 Approbations: TUV SAA CE

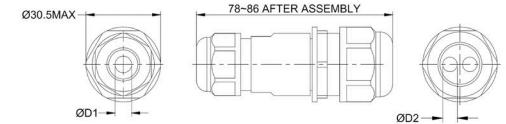

PART NUMBER	FOR CABLE ØD1(MM)	FOR CABLE 2xØD2(MM)	PART 1	PART 2	TORQUE(Kgf.cm)	DAMAGE TORQUE(Kgf.cm)
3T-M20-0806H2	4-8.1	4-6.5	M20-H2-06	3 POLE TERMINAL	Small 16.0-19.0 Big 20.0-23.0	Small 40 Big 50
3T-M20-1006H2	7-10.5					



Name: Waterproof Connector  
 Model: 3T-M25-1208H2 3T-M25-1408H2 3T-M25-0808H2  
 Pole: 3 or 4  
 Rated Operation Voltage: 400V  
 Rated Current: 32A  
 Operation Temperature: -40 - 95°C  
 Colour: Black  
 IP Rating: IP68  
 Waterproof depth: 4M  
 Weight: 65g  
 Approbations: TUV SAA CE

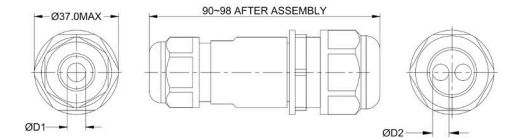

PART NUMBER	FOR CABLE ØD1(MM)	FOR CABLE 2xØD2(MM)	PART 1	PART 2	TORQUE(Kgf.cm)	DAMAGE TORQUE(Kgf.cm)
3T-M25-1208H2	8-12	5.0-8.3	M25-H2-08	3 or 4 POLE TERMINAL	20-23 25-28	50 60
3T-M25-1408H2	10-14					
3T-M25-0808H2	5-8.1					



Name: Waterproof Connector  
 Model: 4T-M32-1210H3 4T-M32-1408H3  
 Pole: 3 or 4  
 Rated Operation Voltage: 400V  
 Rated Current: 32A  
 Operation Temperature: -40 - 95°C  
 Colour: Black  
 IP Rating: IP68  
 Waterproof depth: 4M  
 Weight: 65g  
 Approbations: TUV SAA CE

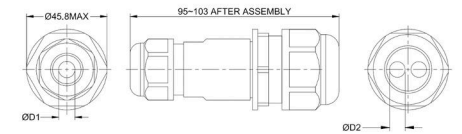

PART NUMBER	FOR CABLE ØD1(MM)	FOR CABLE 2xØD2(MM)	PART 1	PART 2	TORQUE(Kgf.cm)	DAMAGE TORQUE(Kgf.cm)
4T-M32-1211H2	8-12	8.0-11.5	M32-H2-11	3 or 4 POLE TERMINAL	20-23 40-45	50 80
4T-M32-1411H2	10-14					



Name: Waterproof Connector  
 Model: 4T-M25-0808H3 4T-M25-1208H3 4T-M25-1408H3  
 Pole: 3 or 4  
 Rated Operation Voltage: 400V  
 Rated Current: 32A  
 Operation Temperature: -40 - 95°C  
 Colour: Black  
 IP Rating: IP68  
 Waterproof depth: 4M  
 Weight: 65g  
 Approbations: TUV SAA CE

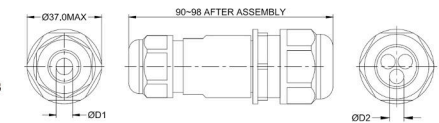

PART NUMBER	FOR CABLE ØD1(MM)	FOR CABLE 3xØD2(MM)	PART 1	PART 2	TORQUE(Kgf.cm)	DAMAGE TORQUE(Kgf.cm)
4T-M25-0808H3	5-8.1	5.0-8.0	M25-H3-08	3 or 4 POLE TERMINAL	20-23 25-28	50 60
4T-M25-1208H3	8-12					
4T-M25-1408H3	10-14					



Name: Waterproof Connector  
 Model: 4T-M32-1201H2 4T-M32-1408H3  
 Pole: 3 or 4  
 Rated Operation Voltage: 400V  
 Rated Current: 32A  
 Operation Temperature: -40 - 95°C  
 Colour: Black  
 IP Rating: IP68  
 Waterproof depth: 4M  
 Weight: 80g  
 Approbations: TUV SAA CE

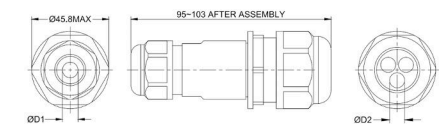

PART NUMBER	FOR CABLE ØD1(MM)	FOR CABLE 3xØD2(MM)	PART 1	PART 2	TORQUE(Kgf.cm)	DAMAGE TORQUE(Kgf.cm)
4T-M32-1210H3	8-12	7.0-10.5	M32-H3-10	3 or 4 POLE TERMINAL	20-23 40-45	50 80
4T-M32-1410H3	10-14					

## PRODUCT FITTING ACCESSORIES



Model: 5T-M25-0806H4 5T-M25-1206H4 5T-M25-1406H4  
 Pole: 3 or 4  
 Rated Operation Voltage: 400V  
 Rated Current: 32A  
 Operation Temperature: -40 ~ 95°C  
 Colour: Black  
 IP Rating: IP68  
 Waterproof depth: 4M  
 Weight: 65g  
 Approbations: TUV SAA

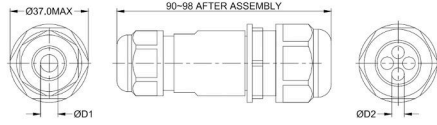

PART NUMBER	FOR CABLE ØD1 (MM)	FOR CABLE 4x ØD2 (MM)	PART 1	PART 2	TORQUE (kgf.cm)	DAMAGE TORQUE (kgf.cm)
5T-M25-0806H4	5-8.1	4.0-6.5	M25-H4-06	3 or 4 POLE TERMINAL	20-23 25-28	50 60
5T-M25-1206H4	8-12					
5T-M25-1406H4	10-14					



Name: Waterproof connection plug  
 Model: S06  
 Input: max 500V  
 rated current: 8A  
 IP Rating: IP68  
 Applicable Diameter of Cable: 5---9mm



UY2 quick waterproof connector  
 Use cable 0.2-0.5mm<sup>2</sup>  
 not suitable for high voltage



FQ16-2P waterproof extended line

Model: FQ16-2P Waterproof adapter  
 Approval: CE  
 Current: 10A MAX  
 Colour: Black  
 IP Rating: IP67



M20B waterproof Male&Female plug



M20B waterproof Male&Female plug extended line

Model: M20B-2P Tee waterproof connector  
 M20B-2P waterproof Male&Female plug  
 Approval: CE  
 Current: 15A MAX  
 Colour: Black  
 IP Rating: IP67

Model: M20B-4P Tee waterproof connector  
 M20B-4P waterproof Male&Female plug  
 Approval: CE  
 Current: 12A MAX  
 Colour: Black  
 IP Rating: IP67

## PRODUCT FITTING ACCESSORIES

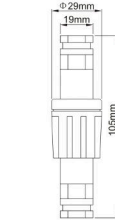

Model: WJM2/4P  
 Applied Type:  
 Voltage: 0-250V AC MAX  
 Electric Current: 6A MAX  
 Colour: Black  
 IP Rating: IP68  
 Applicable Diameter of Cable: 5-8mm

Weight: 38g  
 Approbations: C C

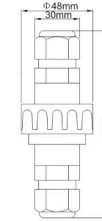

Model: WJ-4P  
 Applied Type:  
 Voltage: 0-250V AC MAX  
 Electric Current: 10A MAX  
 Colour: Black  
 IP Rating: IP68  
 Applicable Diameter of Cable: 6-10mm

Weight: 94g  
 Approbations: C C



Name: Parallel T type three way waterproof plug connector 2P / 4P  
 Model: 3T  
 Input: max 300V  
 rated current: 13A  
 IP Rating: IP67  
 Applicable Diameter of Cable: 5---9mm  
 Insulator material: Nylon  
 Connection mode: screw type

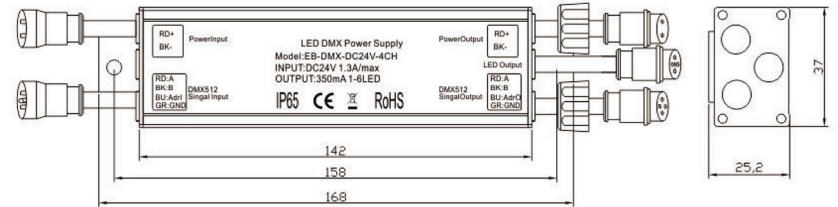

EB-DMX-DC24V-6X1W-4CH  
 LED DMX Power Supply  
 Input Voltage: DC24V  
 Output Current: 350mA/CH\*4CH  
 Output Power: 1-6W\*4CH  
 Driving quantity: 1-6pcs hi-power LED x 4CH  
 350mA: 1-6pcs hi-power 1W LED

EB-DMX-12X1W-4CH  
 LED DMX Power Supply  
 Input Voltage: DC48V  
 Output Current: 350mA/CH\*4CH  
 Output Power: 10-12W\*4CH  
 Driving quantity: 10-12pcs hi-power LED x 4CH  
 350mA: 1-6pcs hi-power 1W LED



**DX8**  
 RGB Touch Panel  
 Input Voltage: 100-240VAC  
 Output Signal: RF2.4G+DMX512  
 RF Remote Distance: 30M  
 Control Mode: 4 Zones Control



Mini M3+M3-3A

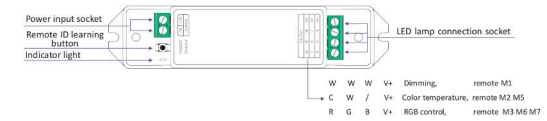
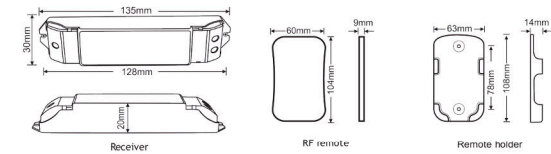

**1. Parameter:**

**Receiver:**

Model: M3-3A  
 Power Input: 12-24V DC  
 Max Current Load: Max 3Ax3CH  
 Max Output Power: 108W(12V)216W(24V)  
 Working Temp: -30°C-55°C  
 Dimensions: L135xW30xH20(mm)  
 Weight(N.W.): 47g  
 Total Weight(G.W.): 135g

**Receiver:**

Model: M3/M6/M7  
 Working Voltage: 3V(battery CR2032)  
 Working Frequency: 433.92MHz  
 Remote Distance: 30m  
 Working Temp: -30°C-55°C  
 Dimensions: L104xW58xH9(mm)  
 Weight(N.W.): 42g

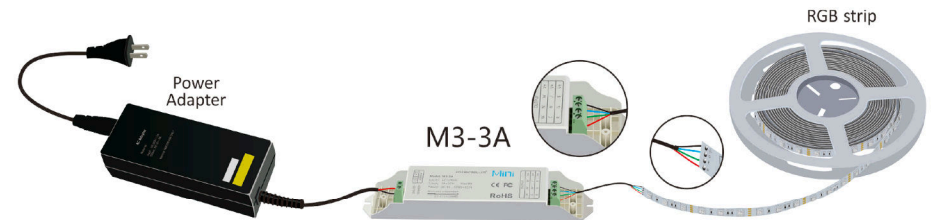

## GROUND LIGHT

				
P07/08 EU1960	P09/10 EU1920	P11/12 EU1965H	P13/14 EU1968	P15/16 BL100
				
P17/18 GL310	P19/20 GL240	P21/22 GL180	P23/24 GL120	P25/26 GL080
				
P27/28 GL112	P29/30 GL112H	P31/32 GL116	P33/34 GL116H	P35/36 GL116Q
				
P37/38 GL116SQ	P39/40 GL118	P41/42 GL118T	P43/44 GL119	P45/46 GL119T
				
P47/48 GL119CT	P49/50 GL119SQ	P51/52 GL129	P53/54 GL108	P55/56 GL308
				
P57/58 GL117	P59/60 GL130	P61/62 GL140	P63/64 GL140SQ	P65/66 GL150
				
P67/68 GL550RGB	P69/70 GL151	P71/72 GL166	P73/74 GL168	P75/76 GL191
				
P77/78 GL266	P79/80 GL268			

## FOUNTAIN LIGHT

	
P83/84 FL410	P85/86 FL411

## SPOT LIGHT

				
P89/90 EU3036	P91/92 EU3040	P93/94 EU3042	P95/96-PL608	P97/98-PL612
				
P99/100 PL618	P101/102 PL624	P103/104 PL824	P105/106 PL021	P107/108 PL023
				
P109/110 PL023-2L	P111/112 PL026			

## LINE LIGHT

				
P115/116 EU2009	P117/118 EU2009HP	P119/120 EU2001	P121/122 EU2006	P123/124 LL700
				
P125/126 LL710				

## LED COMPONENTS

	
P129/130 LED03	P131/132 LED09

## WALL LIGHT

				
P135/136 EU1808	P137/138 EU1820	P139/140 ML101	P141/142 ML102	P143/144 ML102-L
				
P145/146 ML103	P147/148 ML104	P149/150 ML105	P151/152 ML110	P153/154 ML110-L

## SPIKE LIGHT



P157/158 SL100



P159/160 SL131



P161/162 SL133

## QUICK INSTALL LIGHT



P165/166 GL116D-LS



P167/168 GL116DMX-LS



P169/170 GL118RGB-LS

## ACCESSORIES



P173 TS130



P173 TS166



P173 TS140



P173 TS116



P173 TS119



P173 TS119T



P173 TS118



P173 TS118T



P173 TS112



P174 LSV3A



P174 LMC15W350-Z



P174 LSC6W350



P174 LBC20W350-Z



P174 LIC9W350-Z



P174 APC-35-350



P175  
CertaDrive 15W 0.35A 42V



P175  
CertaDrive 25W 0.6A 42V



P175 DE-60



P175 EVOS7W350



P176  
EIP68-1A EIP68-1B EIP68-1C



P176  
EIP68-2A EIP68-2B EIP68-2C



P176  
EIP68-3A EIP68-3B EIP68-3C  
EIP68-3D



P176  
EIP68-3A EIP68-5A EIP68-5B  
EIP68-5C EIP68-5D



P177  
KJ-PG9-07 KJ-PG9-05



P177  
KJ-PG9-08



P177  
KJ-M205-07 KJ-M205-11 KJ-M205-07  
KJ-M205-11



P177  
KJ-M255-08 KJ-M255-10  
KJ-M255-12 KJ-M255-1224



P177  
KJ5-M255-08 KJ5-M255-10  
KJ5-M255-12 KJ5-M255-1224



P178  
3T-M20-0806H2 3T-M20-1006H2



P178  
3T-M25-1208H2 3T-M25-1408H2  
3T-M25-0808H2



P178  
34T-M32-1210H3 4T-M32-1408H3



P178  
4T-M25-0808H3 4T-M25-1208H3  
4T-M25-1008H3



P178  
4T-M32-1201H2 4T-M32-1408H3



P179  
5T-M25-0806H4 5T-M25-1206H4  
5T-M25-1406H4



P179 S-60



P179 UY2



P179 FQ16-2P



P179 M20B



P180 WJM2/4P



P180 WJ-4P



P180 3T



P180  
EB-DMX-DC24V-6X1W-4CH



P180  
EB-DMX-12X1W-4CH



P181 DX8



P182 M3-3A

# Samui phangan real estate

BUYING • RENOVATING INVESTING • LIVING

## CALLISTO VILLAS

Unsurpassed Eco Friendly Luxury

Outdoor Living Trends For 2015

Seara Sports  
Your Only Fitness Solution



P191  
3T